

Overview

The HP ProLiant DL380p Gen8 sets the next generation standards of 2U 2-socket rack servers for the industry. With enhanced configuration flexibility, unmatched performance, and leading energy efficient design the DL380p Gen8 offers the perfect solution for the dynamic compute requirements of today's demanding datacenters.

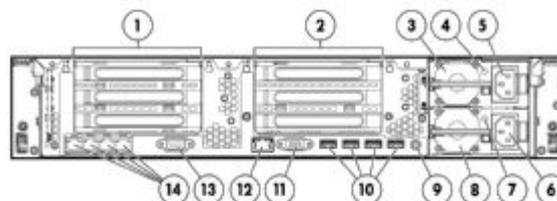
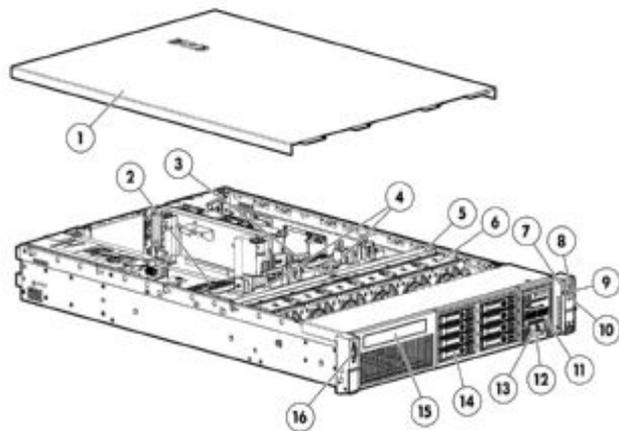

Front View:

1. Quick removal access panel
2. Second Intel Processor
3. First Intel Processor
4. 24 DIMM slots: DDR3 Registered (RDIMM), Load Reduced (LRDIMM), or Unbuffered (UDIMM) memory
5. Air Baffle
6. Hot-plug fans, full N+1 redundancy
7. Health LED
8. Power On /Standby button and system power LED button
9. USB connector
10. Unit ID LED
11. Systems Insight Display
12. Asset Tag
13. USB connector
14. Drive Bays
15. Optional Slim Optical Bay (SATA DVD-RW /ROM Optical Drive)
16. Video connector

Rear View:

1. PCIe 3.0 Slots 1, 2, 3-PCIe 2.0 top to bottom
2. PCIe 3.0 Slots 4-6 top to bottom
3. Power supply 1
4. Power supply 1 Power LED
5. Power supply 1 Power connection (with Intelligent PDU communication)
6. Power supply 2 Power connection (with Intelligent PDU communication)
7. Power supply 2 Power LED
8. Power supply 2
9. Unit ID LED/Button
10. USB connectors (4)
11. Video connector
12. iLO connector
13. Serial connector
14. FlexibleLOM ports (Shown: 4 ports 1Gb each /Optional: 2 ports 10Gb each)

What's New

- Intel® Xeon® E5-2600 v2 Series Processors
- 1866 MHz DDR3 Memory
- New FlexibleLOM Adapters including the HP FlexFabric 10Gb 2-port 533FLR-T Adapter
- New Smart Array P430 & P431 Controllers
- 96% Efficient Titanium Power Supply
- 3TB ioDrive2 IO Accelerator

Standard Features

NOTE: For the Standard Features shipped in the "Factory Integrated Models", please see the "Configuration Information - Factory Integrated Models" section.

Processor
One of the following
depending on Model

E5-2600 v2 series Processors

Entry Processors

NOTE: All support up to 1333MHz DDR3 memory speeds.

Intel® Xeon® E5-2609 v2 (2.5GHz/4-core/10MB/6.4GT-s QPI/80W)

Intel® Xeon® E5-2603 v2 (1.8GHz/4-core/10MB/6.4GT-s QPI/80W)

Base Processors

NOTE: All support up to 1600MHz DDR3 memory speeds.

Intel® Xeon® E5-2640 v2 (2.0GHz/8-core/20MB/7.2GT-s QPI/95W, DDR3-1600, HT, Turbo2-3/3/3/3/3/4/5)

Intel® Xeon® E5-2630 v2 (2.6GHz/6-core/15MB/7.2GT-s QPI/80W, DDR3-1600, HT, Turbo2-3/3/3/3/4/5)

Intel® Xeon® E5-2620 v2 (2.1GHz/6-core/15MB/7.2GT-s QPI/80W, DDR3-1600, HT, Turbo2-3/3/3/3/4/5)

Intel® Xeon® E5-2650L v2 (1.7GHz/10-core/25MB/8.0GT-s QPI/70W, DDR3-1600, HT, Turbo2-2/2/2/2/2/2/2/3/4)

Intel® Xeon® E5-2630L v2 (2.4GHz/6-core/15MB/7.2GT-s QPI/60W, DDR3-1600, HT, Turbo2-2/2/2/2/3/4)

Performance Processors

NOTE: All support up to 1866MHz DDR3 memory speeds.

Intel® Xeon® E5-2697 v2 (2.7GHz/12-core/30MB/8.0GT-s QPI/130W, DDR3-1866, HT, Turbo2-3/3/3/3/3/3/4/5/6/7/8)

Intel® Xeon® E5-2695 v2 (2.4GHz/12-core/30MB/8.0GT-s QPI/115W, DDR3-1866, HT, Turbo2-4/4/4/4/4/4/4/5/6/7/8)

Intel® Xeon® E5-2690 v2 (3.0GHz/10-core/25MB/8.0GT-s QPI/130W, DDR3-1866, HT, Turbo2-3/3/3/3/3/3/4/5/6)

Intel® Xeon® E5-2680 v2 (2.8GHz/10-core/25MB/8.0GT-s QPI/115W, DDR3-1866, HT, Turbo2-3/3/3/3/3/4/5/6/7/8)

Intel® Xeon® E5-2670 v2 (2.5GHz/10-core/25MB/8.0GT-s QPI/115W, DDR3-1866, HT, Turbo2-4/4/4/4/4/4/5/6/7/8)

Intel® Xeon® E5-2667 v2 (3.3GHz/8-core/25MB/8.0GT-s QPI/130W, DDR3-1866, HT, Turbo2-3/3/3/3/4/5/6/7)

Intel® Xeon® E5-2660 v2 (2.2GHz/10-core/25MB/8.0GT-s QPI/95W, DDR3-1866, HT, Turbo2-4/4/4/4/4/4/5/6/7/8)

Intel® Xeon® E5-2650 v2 (2.6GHz/8-core/20MB/8.0GT-s QPI/95W, DDR3-1866, HT, Turbo2-4/4/4/4/5/6/7/8)

Intel® Xeon® E5-2643 v2 (3.5GHz/6-core/25MB/8.0GT-s QPI/130W, DDR3-1866, HT, Turbo2-1/1/1/1/2/3)

Intel® Xeon® E5-2637 v2 (3.5GHz/4-core/15MB/8.0GT-s QPI/130W, DDR3-1866, HT, Turbo2-1/1/2/3)

E5-2600 series Processors

Entry Processors

NOTE: All support up to 1066MHz memory speeds.

Intel® Xeon® E5-2609 (2.4GHz/4-core/10MB/6.4GT-s QPI/80W)

Intel® Xeon® E5-2603 (1.8GHz/4-core/10MB/6.4GT-s QPI/80W)

Standard Features

Base Processors

NOTE: All support up to 1333MHz DDR3 memory speeds.

Intel® Xeon® E5-2640 (2.5GHz/6-core/15MB/7.2GT-s QPI/95W, DDR3-1333, HT, Turbo2-3/3/4/4/5/5)

Intel® Xeon® E5-2630 (2.3GHz/6-core/15MB/7.2GT-s QPI/95W, DDR3-1333, HT, Turbo2-3/3/4/4/5/5)

Intel® Xeon® E5-2620 (2.0GHz/6-core/15MB/7.2GT-s QPI/95W, DDR3-1333, HT, Turbo2-3/3/4/4/5/5)

Intel® Xeon® E5-2630L (2.0GHz/6-core/15MB/8.0GT-s QPI/60W, DDR3-1333, HT, Turbo2-3/3/4/4/5/5)

Performance Processors

NOTE: All support up to 1600MHz DDR3 memory speeds.

Intel® Xeon® E5-2690 (2.9GHz/8-core/20MB/8.0GT-s QPI/135W, DDR3-1600, HT, Turbo2-4/4/4/5/5/7/7/9)

Intel® Xeon® E5-2680 (2.7GHz/8-core/20MB/8.0GT-s QPI/130W, DDR3-1600, HT, Turbo2-4/4/5/5/5/7/8/8)

Intel® Xeon® E5-2670 (2.6GHz/8-core/20MB/8.0GT-s QPI/115W, DDR3-1600, HT, Turbo2-4/4/5/5/6/6/7/7)

Intel® Xeon® E5-2667 (2.9GHz/6-core/15MB/8.0GT-s QPI/130W, DDR3-1600, HT, Turbo2-3/3/3/4/5/6)

Intel® Xeon® E5-2665 (2.4GHz/8-core/20MB/8.0GT-s QPI/115W, DDR3-1600, HT, Turbo2-4/4/5/5/6/6/7/7)

Intel® Xeon® E5-2660 (2.2GHz/8-core/20MB/8.0GT-s QPI/95W, DDR3-1600, HT, Turbo2-5/5/6/6/7/7/8/8)

Intel® Xeon® E5-2650 (2.0GHz/8-core/20MB/8.0GT-s QPI/95W, DDR3-1600, HT, Turbo2-4/4/5/5/5/7/8/8)

Intel® Xeon® E5-2650L (1.8GHz/8-core/20MB/8.0GT-s QPI/70W, DDR3-1600, HT, Turbo2-2/2/3/3/4/4/5/5)

Intel® Xeon® E5-2643 (3.3GHz/4-core/10MB/8.0GT-s QPI/130W, DDR3-1600, HT, Turbo2-1/1/2/2)

Intel® Xeon® E5-2637 (3.0GHz/2-core/5MB/8.0GT-s QPI/80W, DDR3-1600, HT, Turbo2- 5/5)

NOTE: HT indicates that the processor model supports Intel® Hyper-Threading Technology.

NOTE: Turbo indicates the maximum potential frequency increment when using Intel® Turbo Boost Technology, with 8, 7, 6, 5, 4, 3, 2 or 1 core(s) active.

NOTE: DDR3 speed is the maximum memory speed of the processor. Actual memory speed may depend on the quantity and type of DIMMs installed.

NOTE: Up to 2 processors supported. Mixing different processor models is not supported.

NOTE: For the Intel® C600 Chipset E5-2600 Series, the letter preceding the model number indicates the Product Line (E3, E5, E7); 2600x, 2 = number of CPUs in a Node, 6 is socket/segment designation, 00 = Processor SKU, and x = L for low power SKUs.

Standard Features

Cache Memory

One of the following depending on Model

30MB (1x30MB) Level 3

NOTE: For Twelve-core processors.

25MB (1x25MB) Level 3

NOTE: For Ten-core processors.

20MB (1x20MB) Level 3

NOTE: For Eight-core processors.

15MB (1x15MB) Level 3

NOTE: For Six-core processors.

10MB (1x10MB) Level 3

NOTE: For Quad-core processors.

5MB (1x5MB) Level 3

NOTE: For Dual-core processors.

NOTE: All processor models above list the L3 Cache associated with that particular processor.

Chipset

Intel® C600 Series Chipset

Intel® E5-2600 and E5-2600 v2 Processor Families

NOTE: For more information regarding Intel chipsets, please see the following URL:

<http://www.intel.com/products/server/chipsets/>.

Upgradeability

Upgradeable to 2 processors (24 Cores)

NOTE: Processor upgrade available from Intel® Xeon® Processors E5-2600 to E5-2600 v2. Please contact HP Technology Sales (<http://www.hp.com/support>), your local HP Re-seller, or reference the following Customer Advisory: [ProLiant Servers-Instructions for Upgrading an HP ProLiant Gen8 Server from an Intel Xeon Processor E5-2600 to an Intel Xeon Processor E5-2600 v2](#), regarding critical details before upgrading. An explanation of requirements and limitations are provided.

Up to 24 DIMM slots available for higher Memory capacity

FlexibleLOM connector for 1 Gigabit or 10 Gigabit networking options

8SFF Hard drive bays (16SFF with optional upgrade), 8LFF, 12LFF, or 25SFF

Optional 3 slot riser (x16, x8, x8), or 2 slot (x16, x16)

NOTE: To take advantage of the additional 3 PCI slot upgrade, the second processor must be installed.

Redundant Power Supply

Optical Drive (8SFF/8LFF only)

On System

Management Chipset

HP iLO (Firmware: HP iLO 4)

NOTE: For more information, visit: <http://www.hp.com/go/ilo>

Standard Features

Memory Protection

Advanced ECC

NOTE: Advanced ECC uses single device data correction (SDDC) to detect and correct single and all multi-bit error that occurs within a single DRAM chip. Both x4 and x8 SDDC are supported (x8 requires lockstep mode).

Online Spare

NOTE: Memory online spare mode (also known as rank spare mode) detects a rank that is degrading and switches operation to the spare rank.

Lock-step mode

NOTE: Memory Lockstep mode is used to correct a single x8 DRAM device failure on a DIMM. The DIMMs in each paired memory channel must have identical HP part numbers.

Memory

One of the following depending on Model

| | |
|---------------------------|--|
| Type | HP SmartMemory DDR3 Load Reduced (LRDIMM), Registered (RDIMM) or Unbuffered (UDIMM) |
| DIMM Slots Available | 24 (12 DIMM slots per processor /4 channels per processor/3 DIMMs per channel) |
| Maximum Capacity (LRDIMM) | 768GB (24 x 32GB LRDIMM @1066MHz) |
| Maximum Capacity (RDIMM) | 384GB (24x 16GB RDIMM @1333MHz) |
| Maximum Capacity (UDIMM) | 128GB (16 x 8GB UDIMM @1600MHz) |
| Maximum Capacity (HDIMM) | 768GB (24 x 32GB HDIMM @1333MHz) |

NOTE: HP memory from previous generation servers are not qualified or warranted with this HP ProLiant Server. HP SmartMemory is required to realize the memory performance improvements and enhanced functionality listed in this document for Gen8. For additional information, please see the HP SmartMemory QuickSpecs at:

http://h18000.www1.hp.com/products/quickspecs/14225_div/14225_div.html

NOTE: LRDIMM, RDIMM, UDIMM, and HDIMMs are all distinct memory technologies and cannot be mixed within a server. The majority of ProLiant Gen8 servers support RDIMM, UDIMM and LRDIMM.

NOTE: If only one processor is installed, only half the DIMM slots are available.

NOTE: UDIMM max DIMM population is 16.

NOTE: Depending on the memory configuration and processor model, the memory speed may run at 1866MHz, 1600MHz, 1333MHz, or 1066MHz. Please see Memory Population Table or the Online Memory Configuration Tool at: www.hp.com/go/ddr3memory-configurator.

Standard Features

Network Controller One of the following depending on Model

HP ProLiant Gen8 servers offer a new flexible network technology - FlexibleLOMs. The HP ProLiant DL380p Gen8 server offers the customer the choice of 1Gb, 10Gb, or 10Gb base-T networking solutions. For additional details see the Networking Section of this document.

| | |
|--|---|
| Entry Models | HP Ethernet 1Gb 4-port 331FLR Adapter |
| Base Models | HP Ethernet 1Gb 4-port 331FLR Adapter |
| 25SFF Models | HP FlexFabric 10Gb 2-port 533FLR-T Adapter |
| Performance Models | HP Ethernet 10Gb 2-port 530FLR-SFP+ Adapter |
| One of the following depending on Model | HP Ethernet 1Gb 4-port 331FLR Adapter HP FlexFabric 10Gb 2-port 533FLR-T Adapter |
| Energy Star Models | HP Ethernet 1Gb 4-port 331FLR Adapter |

Expansion Slots

Primary Riser (Standard)

| Expansion Slots # | Technology | Bus Width** | Connector Width | Bus Number* | Form Factor | Notes |
|-------------------|------------|-------------|-----------------|-------------|-------------------------------|---------|
| 1 | PCIe 3.0 | X16 | X16 | 7 | Full Length, Full Height Slot | Proc 1 |
| 2 | PCIe 3.0 | X8 | X8 | 10 | Half Length, Full Height Slot | Proc 1 |
| 3 | PCIe 2.0 | X4 | X8 | 13 | Half Length, Full Height Slot | Chipset |

* Default bus assignment (in decimal). Inserting cards with PCI bridges may alter the actual bus assignment number

** Indicates the number of physical electrical lanes running to the connector.

NOTE: When populating the second optional riser slot, the second processor must be installed.

NOTE: All slots support up to 150w PCIe cards, but an additional Power Cord Option is required (PN 669777-B21). See Option Section below for offering.

PCIe Riser (Optional 3-slot)

| Expansion Slots # | Technology | Bus Width** | Connector Width | Bus Number* | Form Factor | Notes |
|-------------------|------------|-------------|-----------------|-------------|-------------------------------|--------|
| 4 | PCIe 3.0 | X16 | X16 | 16 | Full length, full height slot | Proc 2 |
| 5 | PCIe 3.0 | X8 | X8 | 20 | Half length, full height slot | Proc 2 |
| 6 | PCIe 3.0 | X8 | X8 | 23 | Half length, full height slot | Proc 2 |

* Default bus assignment (in decimal). Inserting cards with PCI bridges may alter the actual bus assignment number

** Indicates the number of physical electrical lanes running to the connector.

NOTE: When populating the second optional riser slot, the second processor must be installed.

NOTE: All slots support up to 150w PCIe cards, but an additional Power Cord Option is required (669777-B21). See Option Section below for offering

Standard Features

| PCIe Riser (Optional 2-slot) | Expansion Slots # | Technology | Bus Width** | Connector Width | Bus Number* | Form Factor | Notes |
|---------------------------------|-------------------|------------|-------------|-----------------|-------------|-------------------------------|--------|
| | 4 | PCIe 3.0 | X16 | X16 | 16 | Full length, Full height slot | Proc 2 |
| | 5 | PCIe 3.0 | X16 | X16 | 16 | Half Length, Full Height | Proc 2 |

* Default bus assignment (in decimal). Inserting cards with PCI bridges may alter the actual bus assignment number

** Indicates the number of physical electrical lanes running to the connector.

HP Server ROM

HP ROM (Read Only Memory) is now digitally signed using HP's Corporate Signing Service. This signature is verified before the flash process starts, reducing accidental programming and preventing malicious efforts to corrupt system ROM.

HP ROM provides for essential initialization and validation of hardware components before control is passed to the customer-installed operating system. The ROM also provides the capability of booting from various fixed media (HDD, CD-ROM) and removable media (USB), to continue operation to the operating system.

HP ROM performs very early configuration of the video controller, to allow monitoring of initialization progress via an attached monitor. If configuration or hardware errors are discovered during this early phase of hardware initialization, suitable messages are now displayed on the connected monitor. Additionally, these configuration or hardware errors are logged to the Integrated Management Log (IML) to assist in diagnosis.

HP's ProLiant ROM is used to configure the following:

- Processor and chipset status registers
- System memory, memory map, and memory initialization
- System hardware configuration (Integrated PCI devices and optional PCIe cards).
- Customer-specific BIOS configuration (using the HP ROM-Based Setup Utility (RBSU)).

NOTE: For further information, please refer to HP's RBSU (ROM based setup utility) user guide: www.hp.com/support/rbsu.

Storage Controller One of the following depending on Model

| | |
|--------------------|---|
| Entry Models | HP Smart Array P420i/ZM (RAID 0/1/1+0) |
| Base Models | HP Smart Array P420i/1GB with FBWC (RAID 0/1/1+0/5/5+0/6/6+0) |
| 25SFF Models | HP Smart Array P420i/2GB with FBWC (RAID 0/1/1+0/5/5+0/6/6+0) |
| Performance Models | HP Smart Array P420i/2GB with FBWC (RAID 0/1/1+0/5/5+0/6/6+0) |
| Energy Star Models | HP Smart Array P420i/1GB with FBWC (RAID 0/1/1+0/5/5+0/6/6+0) |

Standard Features

| | | |
|---------------------------------|----------------|---|
| Internal Storage Devices | Diskette Drive | None |
| | Optical Drive | Ships standard in Performance Models Optional: DVD-ROM, DVD-RW |
| | Hard Drives | None ship standard |
| | Drive Bays | Standard: 8SFF drive bays total with Optical Bay, 8 LFF drive bays total with Optical Bay, 12LFF drive bays total, or 25SFF drive bays total Optional: +8SFF drive bay (total of 16SFF drive bays) NOTE: The Optical drive bay is not available with the 12LFF model, 25SFF model, or +8SFF drive bay optional upgrade. NOTE: The 8LFF, 12LFF, and 25SFF drive cage versions are not field upgradeable options from the 8SFF model. NOTE: The optional +8SFF drive bay requires an additional internal storage controller be selected. HP recommends the HP Smart Array P420/1GB FBWC 6Gb 2-ports Int SAS Controller (P/N 631670-B21). NOTE: All Pre-configured Models come populated with some hard drive blanks installed. Should the customer need additional hard drive blanks, they can order more using either P/N 666987-B21: HP SFF Gen8 Hard Drive Blank Kit or P/N 666986-B21: HP LFF Gen8 Hard Drive Blank Kit. The part numbers for single HDD blanks below are also provided should the customer require replacement HDD blanks for their server. |

| | | | |
|---------------------------------|-----------------------|--------|---|
| Maximum Internal Storage | Hot Plug SFF SAS | 30.0TB | 25 x 1.2TB (with optional SFF drive cage) |
| | Hot Plug SFF SATA | 25.0TB | 25 x 1TB (with optional SFF drive cage) |
| | Hot Plug LFF SAS | 36.0TB | 12 x 3TB (with optional LFF drive cage) |
| | Hot Plug LFF SATA | 48.0TB | 12 x 4TB (with optional LFF drive cage) |
| | Hot Plug SFF SAS SSD | 20.0TB | 25 x 800GB (with optional SFF drive cage) |
| | Hot Plug LFF SATA SSD | 9.6TB | 12 x 800GB (with optional LFF drive cage) |

| | | |
|-------------------|---------------------------------------|--|
| Interfaces | Serial | 1 |
| | Video | 2 (1 front, 1 back) not active simultaneously |
| | FlexibleLOM Network Ports | Some models come standard with 4 x 1Gb ports while others come with 2 x 10Gb or 2 x 10Gb base-T ports (See HP Networking section below for more details and options). |
| | HP iLO Remote Management Network Port | 1 Gb Dedicated |
| | SD slot | 1 Internal Secure NOTE: The SD slot is not a hot-pluggable device. Customers should not attempt to plug an SD card into the SD slot while the server is powered. |
| | USB 2.0 Ports | Up to 7 total: up to 2 front, 4 back, 1 internal NOTE: Only 1 front USB port available for 12LFF and 25SFF models. |

Standard Features

| | |
|-------------------------------------|--|
| Industry Standard Compliance | ACPI 2.0b Compliant PCIe 3.0 Compliant PXE Support WOL Support Microsoft® Logo certifications USB 2.0 Compliant |
|-------------------------------------|--|

| | |
|---------------------------|--|
| Server Power Cords | All Pre-configured servers ship with a high voltage server-to-PDU power cord. NOTE: HP ProLiant DL servers no longer ship standard with a 12-foot NEMA 5-15P to C13 power cord that connects to 110V US wall outlets in a home or office. ProLiant DL servers are primarily connected to power distribution units (PDUs) in data center racks and now ship standard with a PDU 6-foot C-14 to C13 power cord (A0K02A). If a user wishes to power a ProLiant DL server using a 110V receptacle (NEMA-15), the 6-foot NEMA 5-15 to C13 power cord must be ordered separately (AF556A). See Power Cords section for Worldwide Power Cord options. |
|---------------------------|--|

| | |
|-----------------------------|---|
| Power Specifications | To review typical system power ratings use the HP Power Advisor which is available via the online tool located at URL: www.hp.com/go/proliant-energy-efficient or www.hp.com/go/hppoweradvisor . NOTE: Power Specification and Technical Content for supported power supplies can be found at: http://h18000.www1.hp.com/products/quickspecs/14209_div/14209_div.html |
|-----------------------------|---|

| | |
|---------------------------------|---|
| Common Slot Power Supply | NOTE: Mixing of power supplies in the same server is not supported. All power supplies inside a server must be exactly the same model. Mixing Gold, Platinum, and Platinum Plus certified power supplies is not supported. |
|---------------------------------|---|

HP's Common Slot (CS) power supplies allow for commonality of power supplies across a wide range of ProLiant and Integrity servers, as well as HP Storage solutions, and are designed to provide the highest power supply efficiency without degrading system performance. HP CS power supplies are tested by the Electric Power Research Institute (EPRI) and certified through the ECOS 80 Plus power supply program. HP CS power supply options provide efficiency ratings of up to 94% (80 Plus Platinum) and are available in three power output options - 460W, 750W, and 1200W - allowing the customer to "right-size" a power supply for their specific server configuration. All HP Common Slot power sources are UL, CE Mark Compliant, hot-plug and support redundant configurations.

NOTE: Mixing of power supplies in the same server is not supported. All power supplies must be of the same output and efficiency rating. If non-matched power supplies are inserted you will get errors and operation will fail.

HP CS Platinum Plus power supplies are required when enabling HP's Intelligent Power Discovery (IPD) solution. IPD is the first technology to create an automated, energy-aware network between IT systems and facilities. This allows your company to reclaim millions of dollars in wasted power capacity and downtime costs across data centers. For more information on HP's IPD solution, go to www.hp.com/go/ipd.

It is highly recommended that you use the HP Power Advisor in defining the "Right-Size" power supply for your needs. HP Power Advisor can be accessed at: www.hp.com/go/hppoweradvisor.

NOTE: The 80 PLUS program is a unique forum that unites electric utilities, the computer industry, and consumers in an effort to bring energy efficient technology solutions to the marketplace. 80 Plus independently tests power supply efficiency and publicly posts the results on 80Plus.org.

Standard Features

Redundant Power: Optional (1+ 1 or n+n redundant) power supplies can be purchased through power supply option kits (see Power Supplies for part numbers).

NOTE: Power Specification and Technical Content for supported power supplies can be found at: http://h18000.www1.hp.com/products/quickspecs/14209_div/14209_div.html

System Fans

One of the following depending on Model

2P Models have (6) (N+1 redundancy standard)

1P Models have (4) (N+1 redundancy standard)

Required Cabling

For required cabling information, refer to the HP Web site at: www.hp.com/servers/dl380p-gen8.

Operating Systems and Virtualization Software Support for ProLiant Servers

[Microsoft Windows Server](#)
[Canonical Ubuntu](#)
[Red Hat Enterprise Linux \(RHEL\)](#)
[SUSE Linux Enterprise Server \(SLES\)](#)
[Oracle Solaris](#)
[VMware](#)
[Citrix XenServer](#)

NOTE: For more information on HP's Certified and Supported ProLiant Servers for OS and Virtualization Software and latest listing of software drivers available for your server, please visit our Support Matrix at: <http://www.hp.com/go/ossupport> and our driver download page: <http://www.hp.com/support/DL380pGen8>

Graphics

Integrated Matrox G200 video standard

- 1280 x 1024 (32 bpp)
- 1920 x 1200 (16 bpp)

HP iLO 4 On System Management Memory

- 16 MB Flash
- 256 MB DDR 3 with ECC (112 MB after ECC and video)

Form Factor

One of the following depending on Model

2U Rack form factor

8 SFF & 25SFF Drive Bay Version:

3.44 (8.74 cm) Height x 17.54" (44.55 cm) Width x 27.5" (69.85 cm) Length

8 LFF & 12LFF Drive Bay Version:

3.44 (8.74 cm) Height x 17.54" (44.55 cm) Width x 29.5" (74.94cm) Length

Standard Features

On System Management

HP iLO Management Engine

- HP iLO Management Engine is a comprehensive set of embedded management features supporting the complete lifecycle of the server, from initial deployment, through ongoing management, to service alerting and remote support. HP iLO Management Engine comes standard on all HP ProLiant Gen8 servers. The HP iLO Management Engine portfolio includes:
 - **HP iLO:** The HP iLO (Integrated Lights-Out) management processor is the core foundation for the HP iLO Management Engine
 - **HP Agentless Management:** Provides built in server health monitoring and alerting capability without OS agents, that starts working the moment a power cord and an Ethernet cable are connected.
 - **HP Active Health System:** Always on, continuous monitoring for increased stability and shorter downtimes; 100% configuration history; Health and service alerts and easy export and upload to Service and Support.
 - **HP Intelligent Provisioning:** Lets customers provision and configure a single server without any separate media. No more SmartStart CDs or Smart Update Firmware DVD are needed.
 - To start Intelligent Provisioning:
 - Press the F10 key during the ProLiant Gen8 server boot process (also known as power on self test or POST).
 - Please go to the Intelligent Provisioning website at www.hp.com/go/intelligentprovisioning for additional information and to view usage videos.
 - Use the Service Pack for ProLiant (SPP) at www.hp.com/go/spp to get firmware and software updates.
 - **HP iLO Mobile App:** Enables the ability to access, deploy, and manage your server anytime from anywhere from select smartphones and mobile devices. For additional information please visit: www.hp.com/go/ilo/mobileapp

NOTE: For more information, visit: <http://www.hp.com/go/ilo> or HP iLO Management Engine technologies whitepaper

Standard Features

HP Insight management HP Service Pack for ProLiant (SPP)

HP Service Pack for ProLiant (SPP) and HP Smart Update Manager (HP SUM) provide a comprehensive approach to firmware and system software maintenance. Together they provide better operating stability and ensure maximum uptime. The SPP will be updated at a predictable cadence, typically coinciding with new HP server hardware launches. By enabling firmware to be updated online and integrating firmware and system software updates in one operation, HP SUM and the SPP offer faster updates of individual servers and dramatically faster updates of entire BladeSystem enclosures. Further improving system uptime and stability is the fact that HP provides 12 months of support for each Service Pack for ProLiant release.

The user experience around HP SUM and the SPP has been improved in several ways, starting with the web download. A single web page provides access to a single download containing both the latest version of HP SUM and the latest SPP. Optional smaller subsets with only specific types of servers or specific operating systems are offered to save on download time. The HP SUM application provides a straightforward, intuitive user interface that guides the user through the steps of discovery, analyses and update, providing comprehensive information on available updates, criticality and interdependencies. This information is also available in reports. By providing the option of multiple local or shared repositories which can be easily updated from hp.com, HP SUM provides the tools to optimize stability and consistency throughout the company. While HP SUM and the SPP recommend the combinations of firmware and system software that HP has found to be the best practice, the application gives customers the flexibility to set their own specific baseline.

The Service Pack for ProLiant has been rigorously tested with specific attention for interaction between firmware, drivers and agents both within the server as well as in interaction with the BladeSystem enclosure components (Onboard Administrator and Virtual Connect). This testing ensures the highest quality as well as providing the input for HP SUM to deploy updates taking into account all interdependencies, when determining the correct updates and order of update deployment.

NOTE: The Service Pack for ProLiant (which includes HP SUM) can be downloaded from www.hp.com/go/spp/download. More information can be found: <http://www.hp.com/go/SmartUpdate>, www.hp.com/go/spp and <http://www.hp.com/go/hpsum>

Security

Power-on password
Serial interface control
Administrator's password

Standard Features

Warranty

This product is covered by a global limited warranty and supported by HP Services and a worldwide network of HP Authorized Channel Partners resellers. Hardware diagnostic support and repair is available for three years from date of purchase. Support for software and initial setup is available for 90 days from date of purchase. Enhancements to warranty services are available through HP Care Pack services or customized service agreements. Hard drives have either a one year or three year warranty; refer to the specific hard drive QuickSpecs for details.

NOTE: Server Warranty includes 3-Year Parts, 3-Year Labor, 3-Year Onsite support with next business day response. Warranty repairs may be accomplished through the use of Customer Self Repair (CSR) parts. These parts fall into two categories: 1) Mandatory CSR parts are designed for easy replacement. A travel and labor charge will result when customers decline to replace a Mandatory CSR part; 2) Optional CSR parts are also designed for easy replacement but may involve added complexity. Customers may choose to have HP replace Optional CSR parts at no charge. Additional information regarding worldwide limited warranty and technical support is available at: <http://h18004.www1.hp.com/products/servers/platforms/warranty/index.html>

Optional Features

HP Insight management HP Insight Control

HP Insight Control, a product option, delivers essential infrastructure management that can help save time and money by making it easy to deploy, migrate, monitor, remote control, and optimize your IT infrastructure through a single, simple management console. HP Insight Control also supports Location and Power Discovery Services to automate many configuration, asset tracking, and power management tasks to speed implementation and prevent downtime. For more information, see <http://www.hp.com/go/insightcontrol>.

HP Insight Control includes one year of 24 x 7 HP Software Technical Support and Update Service ensuring rapid access to HP support staff and proactive delivery of software updates. For more information about this service, see: <http://www.hp.com/services/insight>.

HP iLO Advanced

HP Integrated Lights-Out Advanced License a product option, providing smart remote server management without compromise. iLO Advanced unlocks the full set of remote administration functionality for all HP ProLiant servers by activating the full Virtual Keyboard Video and Mouse remote console, multi-user collaboration, console record and replay, GUI-based and scripted virtual media and virtual folders, and enhanced security and power management functionality. For more information, see: <http://www.hp.com/go/iloadvance>

HP Matrix Operating Environment

The HP Matrix Operating Environment (Matrix OE) for ProLiant and Integrity servers is an integrated command center that helps you instantly adjust to dynamic business demands. This advanced infrastructure management software lets you reduce the cost of common data center tasks by up to 40 percent while keeping pace with your changing business.

The HP Matrix OE includes the automated provisioning, optimization, and recovery management capabilities for HP CloudSystem Matrix, the ideal platform for private cloud and Infrastructure as a Service (IaaS).

NOTE: For more information, visit: <http://www.hp.com/go/matrixoe>

High Performance Clusters

HP Cluster Platforms

HP Cluster Platforms are specifically engineered, factory-integrated large-scale ProLiant clusters optimized for High Performance Computing, with a choice of servers, networks and software. Operating system options include specially priced offerings for Red Hat Enterprise Linux and SUSE Linux Enterprise Server, as well as Microsoft Windows HPC Server. A Cluster Platform Configurator simplifies ordering. <http://www.hp.com/go/clusters>

HP HPC Interconnects

High Performance Computing (HPC) interconnect technologies are available for this server as part of the HP Cluster Platform portfolio. These high-speed InfiniBand and Gigabit interconnects are fully supported by HP when integrated within an HP cluster. Flexible, validated solutions can be defined with the help of configuration tools. <http://www.hp.com/techservers/clusters/ucp/index.html>

Optional Features

HP Insight Cluster Management Utility

HP Insight Cluster Management Utility (CMU) is an HP-licensed and HP-supported suite of tools that are used for lifecycle management of hyperscale clusters of Linux ProLiant systems. CMU includes software for the centralized provisioning, management and monitoring of nodes. CMU makes the administration of clusters user friendly, efficient, and effective. <http://www.hp.com/go/cmu>

Storage Software

Whether you need to solve a specific data protection, archiving, or storage command and control challenge, or deliver on strategic consolidation, compliance, or continuity initiatives, look no further than HP storage software. Our storage software helps you reduce costs, simplify storage infrastructure, protect vital assets and respond faster to business opportunities.

Storage software that gets the job done:

- **Data Protection and Recovery Software**
Whether you're a large enterprise or a smaller business, HP data protection and recovery software will cost-effectively protect you against disaster and ensure business continuity.
- **Data Archive and Migration Software**
HP's storage software enables you to comply with data retention and retrieval requirements, improve application performance, and reduce costs by efficiently migrating infrequently accessed or less valuable data to lower cost storage.
- **Storage Resource Management Software (SRM)**
HP's storage resource management software reduces operational costs and provides the command and control foundation you need to efficiently manage and visualize your physical and virtual environments.
- **Data Replication Software**
HP offers array-based and host-based replication software for use in disaster recovery, testing, application development and reporting.
- **Storage Device Management Software**
Maximize your investment in HP storage and networking with software that enables hardware-specific configuration, performance tuning and connectivity management.
- **HP StoreVirtual VSA**
With HP StoreVirtual VSA you can use the power of virtualization to turn a set of heterogeneous and disconnected physical disk drives in your servers and storage devices into a single pool of logical storage capacity.

NOTE: For more information available Storage Software including QuickSpecs, please see: www.hp.com/go/storage/software

HP Insight Online

HP Insight Online is a new addition to the HP Support Center for one stop, secure access to product and HP support information personalized to your IT environment. Insight Online can automatically display devices remotely monitored by HP Insight Remote Support. With Insight Online's easy navigation you can efficiently track your IT support contracts and device status from anywhere and at anytime. www.hp.com/go/insightonline

Optional Features

HP Proactive Insight experience

Prevent problems with innovative, automated monitoring tools and proactive services. The HP Proactive Insight experience consist of using Insight Online, Insight Remote Support, and Proactive Care Support Service as one integrated solution. The Proactive Insight experience provides you with expert advice and personalized, cloud-based automated IT support, helping to prevent unplanned down time and solve problems quickly. For more information, visit: www.hp.com/go/proactiveinsightexperience

Factory Express Portfolio for Servers and Storage

HP Factory Express offers configuration, customization, integration and deployment services for HP servers and storage products. Customers can choose how their factory solutions are built, tested, integrated, shipped and deployed.

Factory Express offers service packages for simple configuration, racking, installation, complex configuration and design services as well as individual factory services, such as image loading, asset tagging, and custom packaging. HP products supported through Factory Express include a wide array of servers and storage: HP Integrity, HP ProLiant, HP ProLiant Server Blades, HP BladeSystem, HP 9000 servers as well as the MSAXxxx, EVA7xxx, EVA, XP, rackable tape libraries and configurable network switches.

For more information on Factory Express services for your specific server model please contact your sales representative or go to: <http://www.hp.com/go/factory-express>.

HP Simple Configurator

SCE is a guided self-service tool to help sales and non-technical people provide customers with initial configurations in 3 to 5 minutes. You may then send the configuration on for configuration help, or use in your existing ordering processes. If you require "custom" rack configuration or configuration for products not available in SCE, please contact HP's Customer Business Center or an Authorized Partner for assistance. <http://www.hp.com/products/configurator>

Service and Support

Service and Support

HP Technology Services for Industry Standard Servers

Capitalizing on HP ProLiant server capabilities requires a service partner who understands your increasingly complex business technology environment. That's why it makes sense to team up with the people who know HP infrastructure hardware and software best - the experienced professionals at HP Services.

Protect your business beyond warranty with HP Care Pack Services

HP Care Pack services offer complete care and support expertise with committed response choices designed to meet your IT and business needs.

HP Foundation Care services offer scalable reactive support-packages for HP industry-standard servers and software. You can choose the type and level of service that is most suitable for your IT and business needs. HP Proactive Care delivers high levels of system availability through proactive service management and advanced technical response.

Optimized Care

Supports maintaining servers at optimum performance availability

3-Year HP 6 hour Call to Repair Response, Proactive Care*

Combined reactive and proactive support for hardware and software helping optimize your systems and delivering high levels of availability through proactive service management and advanced technical response. Hardware problem resolution to return the hardware in operating condition within 6 hours of the initial service request. A Technical Account Manager, as your single point of contact, will own your call or issue end to end until resolved.

<http://h20195.www2.hp.com/v2/GetPDF.aspx/4AA3-8855EEE.pdf>

HP ProLiant Server Hardware Installation

Provides for the basic hardware installation of HP branded servers, storage devices and networking options to assist you in bringing your new hardware into operation in a timely and professional manner <http://h20195.www2.hp.com/V2/GetPDF.aspx/5981-9356EN.pdf>

Standard Care

Service recommendation that maintains high level of server availability

3-Year HP 24x7 4 hour response, Proactive Care Service*

This service gives you combined reactive and proactive support including rapid access to our Advanced Solution Center to manage and prevent problems and a Technical Support Specialist with a broad level of technical knowledge that will engage with additional technical expertise as needed from HP's vast global resources.

<http://h20195.www2.hp.com/v2/GetPDF.aspx/4AA3-8855EEE.pdf>

HP ProLiant Server Hardware Installation

Provides for the basic hardware installation of HP branded servers, storage devices and networking options to assist you in bringing your new hardware into operation in a timely and professional manner <http://h20195.www2.hp.com/V2/GetPDF.aspx/5981-9356EN.pdf>

Service and Support

Related Services

HP Proactive Care Personalized Support - Environmental Option

The Personalized Support option provides an assigned Account Support Manager who can bring best practices from across the industry plus extra technical skills to your IT team. This option is only available as an add-on to HP Proactive Care Support.

HP Proactive Select Service

Provides a flexible way to purchase HP best-in-class consultancy and technical services. You can buy Proactive Select Service Credits when you purchase your hardware and then use the credits over the next 12 months. <http://h20195.www2.hp.com/V2/GetPDF.aspx/4AA2-3842ENN.pdf>

Additional HP Care Pack services can be found at:

<http://www.hp.com/go/cpc>

Insight Online/Insight Remote Support

HP Insight Remote Support provides 24 X 7 remote monitoring, proactive notifications, and problem resolution. This comes at no additional cost with your HP solution*. Learn more about Insight Remote Support <http://www.hp.com/go/insightremotesupport> and Insight Online <http://www.hp.com/go/insightonline>

* Insight Remote Support is a prerequisite for Proactive Care.

HP Support Center

Personalized online support portal with access to information, tools and experts to support HP business products. Submit support cases online, chat with HP experts, access support resources or collaborate with peers. Learn more <http://www.hp.com/go/hpsc>

HP's Support Center Mobile App* allows you to resolve issues yourself or quickly connect to an agent for live support. Now, you can get access to personalized IT support anywhere, anytime. HP Insight Remote Support and HP Support Center are available at no additional cost with a HP warranty, HP Care Pack, or HP contractual support agreement.

*HP' Support Center Mobile App is subject to local availability

Parts and Material

HP will provide HP-supported replacement parts and materials necessary to maintain the covered hardware product in operating condition, including parts and materials for available and recommended engineering improvements.

Parts and components that have reached their maximum supported lifetime and/or the maximum usage limitations as set forth in the manufacturer's operating manual, product quick-specs, or the technical product data sheet will not be provided, repaired, or replaced as part of these services.

The defective media retention service feature option applies only to Disk or eligible SSD/Flash Drives replaced by HP due to malfunction.

For more information

To learn more on HP ProLiant servers, please contact your HP sales representative or HP Authorized ServiceOne Channel Partner. Or visit: <http://www.hp.com/services/proliant>

Pre-configured Models

NOTE: For the Standard Features shipped in the "Factory Integrated Models", please see the "Configuration Information - Factory Integrated Models" section.

NOTE: Pre-configured models ship with the configurations below. Options can be selected from the Core or Additional options section of this QuickSpecs.

NOTE: HP does not allow factory integration of options into pre-configured models. Any additional options purchased will be shipped separately.

NOTE: If you desire a custom configuration please see "Configuration Information - Factory Integrated Models" section of this QuickSpecs.

NOTE: All Pre-configured Models come populated with some hard drive blanks installed. Should the customer need additional hard drive blanks, they can order more using either P/N 666987-B21: HP SFF Gen8 Hard Drive Blank Kit or P/N 666986-B21: HP LFF Gen8 Hard Drive Blank Kit.

NOTE: Not all models are available in all regions. Check with your local country HP offices for availability.

Entry Models

E5-2600 v2 series Processors

| | |
|---|--|
| <p>HP ProLiant DL380p Gen8 E5-2609v2 1P 4GB-R P420i/ZM 460W PS Server 704560-xx1</p> | <p>Processor(s) (1) Intel® Xeon® E5-2609 v2 (2.5GHz/4-core/10MB/6.4GT-s QPI/80W)</p> <p>Cache Memory 10MB (1x10MB) Level 3</p> <p>Memory 4GB (1x4GB) PC3L-12800R (DDR3-1600LV) Registered DIMMs NOTE: Total 24 DIMM slots available with processor upgrade (2P configuration)</p> <p>Network Controller HP Ethernet 1Gb 4-port 331FLR Adapter</p> <p>Storage Controller HP Smart Array P420i/ZM (RAID 0/1/1+0)</p> <p>Hard Drive None ship standard</p> <p>Internal Storage Standard: 8 SFF SAS/SATA HDD Bays; includes 6 SFF hard drive blanks Optional: +8 SFF (total of 16) SFF SAS/SATA HDD Bays</p> <p>Optical Drive Bay Optional Slim Optical Bay (SATA DVD-RW/ROM Optical Drive)</p> <p>PCI-Express Slots 3 PCIe slots (+3 PCIe slots available with upgrade option)</p> <p>Power Supply (1) HP 460W Common Slot Gold Hot Plug Power Supply (92% Efficient)</p> <p>Fans (4) (N+1 redundancy standard)</p> <p>Management HP iLO Management Engine (standard) Optional: HP Insight Control</p> <p>Energy Star N/A</p> <p>Form Factor Rack (2U), HP Friction Rail Kit NOTE: The HP 2U Gen8 Cable Management Arm is not available when using Friction Rails. NOTE: To assist in the installation of the server into the rack an optional installation tool is available by contacting your local services representative (p/n 695539-001). Caution: HP recommends that a minimum of two people are required for all Rack Server installations. Please refer to your installation instructions for proper tools and number of people to use for any installation.</p> <p>Warranty Server Warranty includes 3-Year Parts, 3-Year Labor, 3-Year Onsite support with next business day response.</p> |
|---|--|

E5-2600 series Processors

| | |
|--|--|
| <p>HP ProLiant DL380p Gen8 E5-2609 1P 4GB-R</p> | <p>Processor(s) (1) Intel® Xeon® E5-2609 (2.4GHz/4-core/10MB/6.4GT-s QPI/80W) Processor</p> |
|--|--|



Pre-configured Models

| | |
|--------------------|--|
| Fans | (4) (N+1 redundancy standard) |
| Management | HP iLO Management Engine (standard) Optional: HP Insight Control |
| Energy Star | N/A |
| Form Factor | Rack (2U), HP Ball Bearing Rail Kit without Cable Management Arm NOTE: To assist in the installation of the server into the rack an optional installation tool is available by contacting your local services representative (p/n 695539-001). Caution: HP recommends that a minimum of two people are required for all Rack Server installations. Please refer to your installation instructions for proper tools and number of people to use for any installation. |
| Warranty | Server Warranty includes 3-Year Parts, 3-Year Labor, 3-Year Onsite support with next business day response. |

E5-2600 series Processors

| | | |
|--|---|---|
| HP ProLiant DL380p Gen8 E5-2640 1P 16GB-R P420i SFF 460W PS Base Server 642107-xx1 | Processor(s) One of the following depending on Model | (1) Intel® Xeon® E5-2640 (2.5GHz/6-core/15MB/7.2GT-s QPI/95W, DDR3-1333, HT, Turbo2- 3/3/4/4/5/5) Processor (1) Intel® Xeon® E5-2630 (2.3GHz/6-core/15MB/7.2GT-s QPI/95W, DDR3-1333, HT, Turbo2- 3/3/4/4/5/5) Processor (1) Intel® Xeon® E5-2620 (2.0GHz/6-core/15MB/7.2GT-s QPI/95W, DDR3-1333, HT, Turbo2- 3/3/4/4/5/5) Processor |
| HP ProLiant DL380p Gen8 E5-2630 1P 16GB-R P420i SFF 460W PS Base Server 642119-xx1 | Cache Memory Memory | 15MB (1x15MB) Level 3 16GB (4x4GB) PC3L-10600R (DDR3-1333) Registered DIMMS NOTE: Total 24 DIMM slots available with processor upgrade (2P configuration) |
| HP ProLiant DL380p Gen8 E5-2620 1P 16GB-R P420i SFF 460W PS Base Server 642120-xx1 | Network Controller Storage Controller Hard Drive Internal Storage Optical Drive Bay PCI-Express Slots Power Supply Fans Management Energy Star Form Factor | HP Ethernet 1Gb 4-port 331FLR Adapter HP Smart Array P420i/1GB FBWC (RAID 0/1/1+0/5/5+0/6/6+0) None ship standard Standard: 8 SFF SAS/SATA HDD Bays; includes 6 SFF hard drive blanks Optional: +8 SFF (total of 16) SFF SAS/SATA HDD Bays Optional Slim Optical Bay (SATA DVD-RW/ROM Optical Drive) 3 PCIe slots (+3 PCI slots available with upgrade option) (1) HP 460W CS Platinum Plus Hot Plug Power Supply (94% Efficient) (4) (N+1 redundancy standard) HP iLO Management Engine (standard) Optional: HP Insight Control Meets Energy Star requirements Rack (2U), HP Ball Bearing Rail Kit/Cable Management Arm standard NOTE: To assist in the installation of the server into the rack an optional installation tool is available by contacting your local services representative (p/n 695539-001). Caution: HP recommends that a minimum of two people are required for all Rack Server installations. Please refer to your installation instructions for proper tools and number of people to use for any installation. |
| | Warranty | Server Warranty includes 3-Year Parts, 3-Year Labor, 3-Year Onsite support with next business day response. |

Pre-configured Models

25SFF Models

NOTE: This Model is Energy Star Certified.

E5-2600 v2 series Processors

| | | |
|--|---|---|
| HP ProLiant DL380p Gen8 E5-2650v2 2P 32GB-R P420i/2GB FBWC 750W RPS Server 704558-xx1 | Processor(s) Cache Memory Memory Network Controller Storage Controller Hard Drive Internal Storage Optical Drive Bay PCI-Express Slots Power Supply Fans Management Energy Star Form Factor Warranty | (2) Intel® Xeon® E5-2650 v2 (2.6GHz/8-core/20MB/8.0GT-s QPI/95W, DDR3-1866, HT, Turbo2- 4/4/4/4/5/6/7/8) 20MB (1x20MB) Level 3 32GB (2x16GB) PC3-14900R (DDR3-1866) Registered DIMMs NOTE: Total 24 DIMM slots available with processor upgrade (2P configuration) HP FlexFabric 10Gb 2-port 533FLR-T Adapter HP Smart Array P420i/2GB FBWC (RAID 0/1/1+0/5/5+0/6/6+0) None ship standard Standard: 25 SFF SAS/SATA HDD Bays; includes 23 SFF hard drive blanks Not available in 25 SFF model 6 PCIe slots (2) HP 750W CS Platinum Plus Hot Plug Power Supply (94% Efficient) (6) (N+1 redundancy standard) HP iLO Management Engine (standard) Optional: HP Insight Control Meets Energy Star requirements Rack (2U), HP Ball Bearing Rail Kit without Cable Management Arm NOTE: To assist in the installation of the server into the rack an optional installation tool is available by contacting your local services representative (p/n 695539-001). Caution: HP recommends that a minimum of two people are required for all Rack Server installations. Please refer to your installation instructions for proper tools and number of people to use for any installation. Server Warranty includes 3-Year Parts, 3-Year Labor, 3-Year Onsite support with next business day response. |
|--|---|---|

Performance Models

NOTE: These Models are Energy Star Certified.

E5-2600 v2 series Processors

| | | |
|--|--|--|
| HP ProLiant DL380p Gen8 E5-2690v2 2P 32GB-R P420i/2GB FBWC 750W RPS Server 709943-xx1 | Processor(s) Cache Memory Memory Network Controller Storage Controller Hard Drive | (2) Intel® Xeon® E5-2690 v2 (3.0GHz/10-core/25MB/8.0GT-s QPI/130W, DDR3-1866, HT, Turbo2- 3/3/3/3/3/3/4/5/6) 25MB (1x25MB) Level 3 32GB (2x16GB) PC3-14900R (DDR3-1866) Registered DIMMs NOTE: Total 24 DIMM slots available with processor upgrade (2P configuration) HP FlexFabric 10Gb 2-port 533FLR-T Adapter HP Smart Array P420i/2GB FBWC (RAID 0/1/1+0/5/5+0/6/6+0) None ship standard |
|--|--|--|

Pre-configured Models

| | |
|--------------------------|--|
| Internal Storage | Standard: 8 SFF SAS/SATA HDD Bays; includes 6 SFF hard drive blanks Optional: +8 SFF (total of 16) SFF SAS/SATA HDD Bays |
| Optical Drive Bay | DVD-RW standard |
| PCI-Express Slots | 6 PCIe slots |
| Power Supply | (2) HP 750W CS Platinum Plus Hot Plug Power Supply (94% Efficient) |
| Fans | (6) (N+1 redundancy standard) |
| Management | HP iLO Management Engine (standard) HP Insight Control Standard |
| Energy Star | Meets Energy Star requirements |
| Form Factor | Rack (2U), HP Ball Bearing Rail Kit without Cable Management Arm NOTE: To assist in the installation of the server into the rack an optional installation tool is available by contacting your local services representative (p/n 695539-001). Caution: HP recommends that a minimum of two people are required for all Rack Server installations. Please refer to your installation instructions for proper tools and number of people to use for any installation. |
| Warranty | Server Warranty includes 3-Year Parts, 3-Year Labor, 3-Year Onsite support with next business day response. |

E5-2600 series Processors

| | | |
|--|--|--|
| HP ProLiant DL380p Gen8 E5-2690 2P 32GB-R P420i SATA SFF 750W PS High Perf Server 662257-xx1 | Processor(s) One of the following depending on Model Cache Memory Memory Network Controller One of the following depending on Model | (2) Intel® Xeon® E5-2690 (2.9GHz/8-core/20MB/8GT-s QPI/135W, DDR3-1600, HT, Turbo2- 4/4/4/5/5/7/7/9) Processor (2) Intel® Xeon® E5-2665 (2.4GHz/8-core/20MB/8GT-s QPI/115W, DDR3-1600, HT, Turbo2- 4/4/5/5/6/6/7/7) Processor (2) Intel® Xeon® E5-2650 (2.0GHz/8-core/20MB/8GT-s QPI/95W, DDR3-1600, HT, Turbo2- 4/4/5/5/5/7/8/8) Processor 20MB (1x20MB) Level 3 32GB (4x8GB) PC3-12800R (DDR3-1600) Registered DIMMS NOTE: Total 24 DIMM slots available. HP Ethernet 10Gb 2-port 530FLR-SFP+ Adapter (on E5-2690/E5-2665 Models) NOTE: SFP Transceivers for the 530FLR-SFP+ are not included with the server and must be purchased separately. HP Ethernet 1Gb 4-port 331FLR Adapter (on E5-2650 Model) |
| HP ProLiant DL380p Gen8 E5-2665 2P 32GB-R P420i SFF 750W PS High Perf Server 642105-xx1 | Storage Controller Hard Drive Internal Storage | HP Smart Array P420i/2GB FBWC (RAID 0/1/1+0/5/5+0/6/6+0) None ship standard Standard: 8 SFF SAS/SATA HDD Bays; includes 6 SFF hard drive blanks Optional: +8 SFF (total of 16) SFF SAS/SATA HDD Bays |
| HP ProLiant DL380p Gen8 E5-2650 2P 32GB-R P420i SFF 750W PS High Perf Server 642106-xx1 | Optical Drive Bay PCI-Express Slots Power Supply Fans Management Energy Star | DVD-RW standard 6 PCIe slots (includes second riser slot upgrade option) (2) HP 750W CS Platinum Plus Hot Plug Power Supplies (94% Efficient) (6) (N+1 redundancy standard) HP iLO Management Engine (standard) HP Insight Control Standard Meets Energy Star requirements |

Pre-configured Models

| | |
|--------------------|---|
| Form Factor | Rack (2U), HP Ball Bearing Rail Kit/Cable Management Arm standard NOTE: To assist in the installation of the server into the rack an optional installation tool is available by contacting your local services representative (p/n 695539-001). Caution: HP recommends that a minimum of two people are required for all Rack Server installations. Please refer to your installation instructions for proper tools and number of people to use for any installation. |
| Warranty | Server Warranty includes 3-Year Parts, 3-Year Labor, 3-Year Onsite support with next business day response. |

Energy Star Models

NOTE: These Models are Energy Star Certified.

E5-2600 v2 series Processors

| | | |
|---|---------------------------|--|
| HP ProLiant DL380p Gen8 E5-2630v2 2P 32GB-R P420i/1GB FBWC 460W PS Server 709942-xx1 | Processor(s) | (2) Intel® Xeon® E5-2630 v2 (2.6GHz/6-core/15MB/7.2GT-s QPI/80W, DDR3-1600, HT, Turbo2- 3/3/3/3/4/5) |
| | Cache Memory | 15MB (1x15MB) Level 3 |
| | Memory | 32GB (2x16GB) PC3L-12800R (DDR3-1600LV) Registered DIMMs NOTE: Total 24 DIMM slots available with processor upgrade (2P configuration) |
| | Network Controller | HP Ethernet 1Gb 4-port 331FLR Adapter |
| | Storage Controller | HP Smart Array P420i/1GB FBWC (RAID 0/1/1+0/5/5+0/6/6+0) |
| | Hard Drive | None ship standard |
| | Internal Storage | Standard: 8 SFF SAS/SATA HDD Bays; includes 6 SFF hard drive blanks Optional: +8 SFF (total of 16) SFF SAS/SATA HDD Bays |
| | Optical Drive Bay | Optional: Slim Optical Bay (SATA DVD-RW/ROM Optical Drive) |
| | PCI-Express Slots | 6 PCIe slots |
| | Power Supply | (1) HP 460W CS Platinum Plus Hot Plug Power Supply (94% Efficient) |
| | Fans | (6) (N+1 redundancy standard) |
| | Management | HP iLO Management Engine (standard) Optional: HP Insight Control |
| | Energy Star | Meets Energy Star requirements |
| | Form Factor | Rack (2U), HP Ball Bearing Rail Kit without Cable Management Arm NOTE: To assist in the installation of the server into the rack an optional installation tool is available by contacting your local services representative (p/n 695539-001). Caution: HP recommends that a minimum of two people are required for all Rack Server installations. Please refer to your installation instructions for proper tools and number of people to use for any installation. |
| | Warranty | Server Warranty includes 3-Year Parts, 3-Year Labor, 3-Year Onsite support with next business day response. |

E5-2600 series Processors

| | | |
|---|---------------------|---|
| HP ProLiant DL380p Gen8 E5-2630 2P 16GB-R P420i Hot Plug SFF | Processor(s) | (2) Intel® Xeon® E5-2630 (2.3GHz/6-core/15MB/7.2GT-s QPI/95W, DDR3-1333, HT, Turbo2- 3/3/4/4/5/5) |
| | Cache Memory | 15MB (1x15MB) Level 3 |

Pre-configured Models

460W PS Server
677278-xx1

| | |
|---------------------------|--|
| Memory | 16GB (4x4GB) PC3L-10600R (DDR3-1333) Registered DIMMS NOTE: Total 24 DIMM slots. |
| Network Controller | HP Ethernet 1Gb 4-port 331FLR Adapter |
| Storage Controller | HP Smart Array P420i/1GB with FBWC (RAID 0/1/1+0/5/5+0/6/6+0) |
| Hard Drive | None ship standard |
| Internal Storage | Standard: 8 SFF SAS/SATA HDD Bays; includes 6 SFF hard drive blanks Optional: +8 SFF (total of 16) SFF SAS/SATA HDD Bays |
| Optical Drive Bay | Optional Slim Optical Bay (SATA DVD-RW/ROM Optical Drive) |
| PCI-Express Slots | 3 PCIe slots (+3 PCI slots available with upgrade option) |
| Power Supply | (1) 460W HP CS Platinum Plus Hot Plug Power Supply (94% Efficient) |
| Fans | (6) (N+1 redundancy standard) |
| Management | HP iLO Management Engine (standard) Optional: HP Insight Control |
| Energy Star | Meets Energy Star requirements |
| Form Factor | Rack (2U), HP Ball Bearing Rail Kit /Cable Management Arm standard NOTE: To assist in the installation of the server into the rack an optional installation tool is available by contacting your local services representative (p/n 695539-001). Caution: HP recommends that a minimum of two people are required for all Rack Server installations. Please refer to your installation instructions for proper tools and number of people to use for any installation. |
| Warranty | Server Warranty includes 3-Year Parts, 3-Year Labor, 3-Year Onsite support with next business day response. |

| | | |
|-------------------------|---------|--------|
| Country Code Key | xx = 00 | U.S. |
| | xx = 20 | Brazil |
| | xx = 29 | Japan |
| | xx = 37 | APD |
| | xx = 42 | Europe |
| | xx = AA | PRC |

NOTE: Not all models have full country support.

Configuration Information - Factory Integrated Models

NOTE: This section lists some of the steps required to configure a Factory Integrated Model. To ensure only valid configurations are ordered, HP recommends the use of an HP approved configurator. Contact your local sales representative for information on configurable product offerings and requirements.

NOTE: Factory Integrated Models must start with a CTO Server.

NOTE: FIO indicates that this option is only available as a factory installable option.

NOTE: All Factory Integrated Models will be populated with sufficient hard drive blanks based on the number of initial hard drives ordered with the server.

Step 1: Base Configuration (choose one of the following configurable models)

HP Models HP ProLiant DL380p Gen8 8 LFF Configure-to-order Server 665553-B21

Factory Integrated Model ships with:

2 x HP Smart Socket Guides for fast processor installation.
 24 DIMM slots for RDIMM, LRDIMM and UDIMM Memory installation
 1 FlexibleLOM connector: (see Step2: HP FlexibleNIC section below for NIC choices to populate the embedded connector)
 Smart Array P420i Controller w/ Zero Memory (ZM)
 I/O slots - 3 Slots come standard:

- Slot 1 - FL/FH x16 PCIe 3.0 (x16 connector)
- Slot 2 - HL/FH x8 PCIe 3.0 (x8 connector)
- Slot 3 - HL/FH x4 PCIe 2.0 (x8 connector)
- Additional Slots may be added via selections from the PCI Information and Options subsection

System Fans - 4 (2 additional fans included with second processor)
 Drive Cage - 8LFF (Optical media drive optional)
 USB - 4 Rear, 2 Front, 1 Internal, 1 SD slot
 HP iLO Management Engine (standard)
NOTE: Power Supply & Rail Kit not included - choose from Step 3 & 4 sections below

NOTE: If a P430 controller is required, it cannot be populated in slots 3 or 4.

HP ProLiant DL380p Gen8 8 SFF Configure-to-order Server 653200-B21

Factory Integrated Model ships with:

1 FlexibleLOM connector: (see Step 2: HP FlexibleLOM section below for NIC choices to populate the embedded connector)
 Smart Array P420i Controller w/ Zero Memory (ZM)
 I/O slots - 3 Slots come standard:

- Slot 1 - FL/FH x16 PCIe 3.0 (x16 connector)
- Slot 2 - HL/FH x8 PCIe 3.0 (x8 connector)
- Slot 3 - HL/FH x4 PCIe 2.0 (x8 connector)
- Additional Slots may be added via selections from the PCI Information and Options subsection

System Fans - 4 (2 additional fans included with second processor)
 Drive Cage - 8SFF (Optical media drive OR Second 8SFF drive cage optional)
 USB - 4 Rear, 2 Front, 1 Internal, 1 SD slot
 HP iLO Management Engine (standard)
NOTE: Power Supply & Rail Kit not included - choose from Step 3 & 4 sections below

NOTE: If a P430 controller is required, it cannot be populated in slots 3 or 4.

HP ProLiant DL380p Gen8 12 LFF Configure-to-order Server 665552-B21

Configuration Information - Factory Integrated Models

Factory Integrated Model ships with:

1 FlexibleLOM connector: (see Step 2: HP FlexibleLOM section below for NIC choices to populate the embedded connector)

Smart Array P420i Controller w/ Zero Memory (ZM)

I/O slots - 3 Slots come standard:

- Slot 1 - FL/FH x16 PCIe 3.0 (x16 connector)
- Slot 2 - HL/FH x8 PCIe 3.0 (x8 connector)
- Slot 3 - HL/FH x4 PCIe 2.0 (x8 connector)
- Additional Slots may be added via selections from the PCI Information and Options subsection

System Fans - 4 (2 additional fans included with second processor)

Drive Cage - 12LFF (with built-in expander)

USB - 4 Rear, 1 Front, 1 Internal, 1 SD slot

HP iLO Management Engine (standard)

NOTE: Power Supply & Rail Kit not included - choose from Step 3 & 4 sections below

NOTE: Customers can only choose from 115W or lower E5-2600 and E5-2600 v2 processors in this configure-to-order model.

NOTE: This chassis comes with a built-in expander. All drives can be driven off of the embedded P420i controller.

NOTE: Customers must add a minimum of a 512MB controller cache module when choosing this CTO server.

NOTE: If a P822 controller is required, it cannot be populated in slot 3.

NOTE: If a P421 controller is required, it cannot be populated in slot 1.

NOTE: If a P430 controller is required, it cannot be populated in slots 3 or 4.

NOTE: HyperCloud DIMMs, Q4000, and Q6000 options are not supported in this CTO server.

NOTE: Customer will not be able to get an optical drive, SID, second front USB, and ID label.

HP ProLiant DL380p Gen8 25 SFF Configure-to-order Server

665554-B21

Factory Integrated Model ships with:

1 FlexibleLOM connector: (see Step 2: HP FlexibleLOM section below for NIC choices to populate the embedded connector)

Smart Array P420i Controller w/ Zero Memory (ZM)

I/O slots - 3 Slots come standard:

- Slot 1 - FL/FH x16 PCIe 3.0 (x16 connector)
- Slot 2 - HL/FH x8 PCIe 3.0 (x8 connector)
- Slot 3 - HL/FH x4 PCIe 2.0 (x8 connector)
- Additional Slots may be added via selections from the PCI Information and Options subsection

System Fans - 4 (2 additional fans included with second processor)

Drive Cage - 25SFF (with built-in expander)

USB - 4 Rear, 1 Front, 1 Internal, 1 SD slot

HP iLO Management Engine (standard)

NOTE: Power Supply & Rail Kit not included - choose from Step 3 & 4 sections below

NOTE: Customers cannot select the E5-2643, E5-2637 v2, nor the E5-2643 v2 processor in this configure-to-order model.

NOTE: This chassis comes with a built-in expander. All drives can be driven off

Configuration Information - Factory Integrated Models

of the embedded P420i controller.

NOTE: Customers must add a minimum of a 512MB controller cache module when choosing this CTO server.

NOTE: If a P822 controller is required, it cannot be populated in slot 3.

NOTE: If a P430 controller is required, it cannot be populated in slots 3 or 4.

NOTE: HyperCloud DIMMs, Q4000, and Q6000 options are not supported in this CTO server.

NOTE: Customer will not be able to get an optical drive, SID, second front USB, and ID label.

Step 2: Choose Required Options (only one of the following from each list unless otherwise noted)

HP Processors

NOTE: If two processors are desired, select one xxxxxx-L21 and one xxxxxx-B21

Entry Processors - E5-2600 v2 series Processors

NOTE: All support up to 1333MHz memory speeds.

HP DL380p Gen8 Intel® Xeon® E5-2609v2 (2.5GHz/4-core/10MB/80W) FIO Processor Kit 715222-L21

HP DL380p Gen8 Intel® Xeon® E5-2603v2 (1.8GHz/4-core/10MB/80W) FIO Processor Kit 715223-L21

Base Processors - E5-2600 v2 series Processors

NOTE: All support up to 1600MHz DDR3 memory speeds.

HP DL380p Gen8 Intel® Xeon® E5-2640v2 (2.0GHz/8-core/20MB/95W) FIO Processor Kit 715219-L21

HP DL380p Gen8 Intel® Xeon® E5-2630v2 (2.6GHz/6-core/15MB/80W) FIO Processor Kit 715220-L21

HP DL380p Gen8 Intel® Xeon® E5-2620v2 (2.1GHz/6-core/15MB/80W) FIO Processor Kit 715221-L21

HP DL380p Gen8 Intel® Xeon® E5-2650Lv2 (1.7GHz/10-core/25MB/70W) FIO Processor Kit 715229-L21

HP DL380p Gen8 Intel® Xeon® E5-2630Lv2 (2.4GHz/6-core/15MB/60W) FIO Processor Kit 715230-L21

Performance Processors - E5-2600 v2 series Processors

NOTE: All support up to 1866MHz DDR3 memory speeds

HP DL380p Gen8 Intel® Xeon® E5-2697v2 (2.7GHz/12-core/30MB/130W) FIO Processor Kit 715224-L21

HP DL380p Gen8 Intel® Xeon® E5-2695v2 (2.4GHz/12-core/30MB/115W) FIO Processor Kit 715225-L21

HP DL380p Gen8 Intel® Xeon® E5-2690v2 (3.0GHz/10-core/25MB/130W) FIO Processor Kit 715214-L21

HP DL380p Gen8 Intel® Xeon® E5-2680v2 (2.8GHz/10-core/25MB/115W) FIO Processor Kit 715215-L21

HP DL380p Gen8 Intel® Xeon® E5-2670v2 (2.5GHz/10-core/25MB/115W) FIO Processor Kit 715216-L21

HP DL380p Gen8 Intel® Xeon® E5-2667v2 (3.3GHz/8-core/25MB/130W) FIO Processor Kit 715226-L21

Configuration Information - Factory Integrated Models

HP DL380p Gen8 Intel® Xeon® E5-2660v2 (2.2GHz/10-core/25MB/95W) FIO Processor Kit 715217-L21

HP DL380p Gen8 Intel® Xeon® E5-2650v2 (2.6GHz/8-core/20MB/95W) FIO Processor Kit 715218-L21

HP DL380p Gen8 Intel® Xeon® E5-2643v2 (3.5 GHz/6-core/25MB/130W) FIO Processor Kit 715227-L21

HP DL380p Gen8 Intel® Xeon® E5-2637v2 (3.5GHz/4-core/15MB/130W) FIO Processor Kit 715228-L21

Entry Processors - E5-2600 series Processors

NOTE: All support up to 1066MHz memory speeds.

HP DL380p Gen8 Intel® Xeon® E5-2609 (2.40GHz/4-core/10MB/80W) FIO Processor Kit 662252-L21

HP DL380p Gen8 Intel® Xeon® E5-2603 (1.80GHz/4-core/10MB/80W) FIO Processor Kit 662254-L21

Base Processors - E5-2600 series Processors

NOTE: All support up to 1333MHz DDR3 memory speeds.

HP DL380p Gen8 Intel® Xeon® E5-2640 (2.5GHz/6-core/15MB/95W) FIO Processor Kit 662246-L21

HP DL380p Gen8 Intel® Xeon® E5-2630 (2.3GHz/6-core/15MB/95W) FIO Processor Kit 662248-L21

HP DL380p Gen8 Intel® Xeon® E5-2620 (2.0GHz/6-core/15MB/95W) FIO Processor Kit 662250-L21

HP DL380p Gen8 Intel® Xeon® E5-2630L (2.0GHz/6-core/15MB/60W) FIO Processor Kit 675092-L21

Performance Processors - E5-2600 series Processors

NOTE: All support up to 1600MHz DDR3 memory speeds

HP DL380p Gen8 Intel® Xeon® E5-2690 (2.9GHz/8-core/20MB/135W) FIO Processor Kit 662226-L21

HP DL380p Gen8 Intel® Xeon® E5-2680 (2.7GHz/8-core/20MB/130W) FIO Processor Kit 662228-L21

HP DL380p Gen8 Intel® Xeon® E5-2670 (2.6GHz/8-core/20MB/115W) FIO Processor Kit 662240-L21

HP DL380p Gen8 Intel® Xeon® E5-2667 (2.9GHz/6-core/15MB/130W) FIO Processor Kit 662214-L21

HP DL380p Gen8 Intel® Xeon® E5-2665 (2.4GHz/8-core/20MB/115W) FIO Processor Kit 666509-L21

HP DL380p Gen8 Intel® Xeon® E5-2660 (2.2GHz/8-core/20MB/95W) FIO Processor Kit 662242-L21

HP DL380p Gen8 Intel® Xeon® E5-2650 (2.0GHz/8-core/20MB/95W) FIO Processor Kit 662244-L21

HP DL380p Gen8 Intel® Xeon® E5-2650L (1.8GHz/8-core/20MB/70W) FIO Processor Kit 662256-L21

HP DL380p Gen8 Intel® Xeon® E5-2643 (3.3GHz/4-core/10MB/130W) FIO Processor Kit 662216-L21

HP DL380p Gen8 Intel® Xeon® E5-2637 (3.0GHz/2-core/5MB/80W) FIO Processor Kit 662224-L21

HP Memory

NOTE: HP memory from previous generation servers are not qualified or warranted with this HP ProLiant Server. HP SmartMemory is required to realize

Configuration Information - Factory Integrated Models

the memory performance improvements and enhanced functionality listed in this document for Gen8. For additional information, please see the HP SmartMemory QuickSpecs at:

http://h18000.www1.hp.com/products/quickspecs/14225_div/14225_div.html

NOTE: LRDIMM, RDIMM, UDIMM, and HDIMMs are all distinct memory technologies and cannot be mixed within a server. The majority of ProLiant Gen8 servers support LRDIMM, RDIMM and UDIMMs.

Registered DIMMs (RDIMMs)

NOTE: The following memory is supported by the E5-2600 v2 series Processors.

| | |
|--|------------|
| HP 4GB (1x4GB) Single Rank x4 PC3L-12800R (DDR3-1600) Registered CAS-11 Low Voltage Memory Kit | 713981-B21 |
| HP 4GB (1x4GB) Single Rank x4 PC3-14900R (DDR3-1866) Registered CAS-13 Memory Kit | 708637-B21 |
| HP 8GB (1x8GB) Dual Rank x4 PC3L-12800R (DDR3-1600) Registered CAS-11 Low Voltage Memory Kit | 713983-B21 |
| HP 8GB (1x8GB) Single Rank x4 PC3L-12800R (DDR3-1600) Registered CAS-11 Low Voltage Memory Kit | 731765-B21 |
| HP 8GB (1x8GB) Dual Rank x4 PC3-14900R (DDR3-1866) Registered CAS-13 Memory Kit | 708639-B21 |
| HP 8GB (1x8GB) Single Rank x4 PC3-14900R (DDR3-1866) Registered CAS-13 Memory Kit | 731761-B21 |
| HP 16GB (1x16GB) Dual Rank x4 PC3L-12800R (DDR3-1600) Registered CAS-11 Low Voltage Memory Kit | 713985-B21 |
| HP 16GB (1x16GB) Dual Rank x4 PC3-14900R (DDR3-1866) Registered CAS-13 Memory Kit | 708641-B21 |

Registered DIMMs (RDIMMs)

NOTE: The following memory is supported by the E5-2600 series Processors.

| | |
|---|------------|
| HP 4GB (1x4GB) Single Rank x4 PC3L-10600R (DDR3-1333) Registered CAS-9 Low Voltage Memory Kit | 647893-B21 |
| HP 4GB (1x4GB) Single Rank x4 PC3-12800R (DDR3-1600) Registered CAS-11 Memory Kit | 647895-B21 |
| HP 8GB (1x8GB) Dual Rank x4 PC3L-10600R (DDR3-1333) Registered CAS-9 Low Voltage Memory Kit | 647897-B21 |
| HP 8GB (1x8GB) Single Rank x4 PC3-12800R (DDR3-1600) Registered CAS-11 Memory Kit | 647899-B21 |
| HP 8GB (1x8GB) Dual Rank x4 PC3-12800R (DDR3-1600) Registered CAS-11 Memory Kit | 690802-B21 |
| HP 16GB (1x16GB) Dual Rank x4 PC3L-10600R (DDR3-1333) Registered CAS-9 Low Voltage Memory Kit | 647901-B21 |
| HP 16GB (1x16GB) Dual Rank x4 PC3-12800R (DDR3-1600) Registered CAS-11 Memory Kit | 672631-B21 |

Unbuffered with ECC DIMMs (UDIMMs)

NOTE: The following memory is supported by the E5-2600 v2 series Processors.

| | |
|--|------------|
| HP 2GB (1x2GB) Single Rank x8 PC3L-12800E (DDR3-1600) Unbuffered CAS-11 Low Voltage Memory Kit | 713975-B21 |
| HP 2GB (1x2GB) Single Rank x8 PC3-14900E (DDR3-1866) Unbuffered CAS-13 Memory Kit | 708631-B21 |

Configuration Information - Factory Integrated Models

HP 4GB (1x4GB) Dual Rank x8 PC3L-12800E (DDR3-1600) Unbuffered CAS-11 Low Voltage Memory Kit 713977-B21

HP 4GB (1x4GB) Dual Rank x8 PC3-14900E (DDR3-1866) Unbuffered CAS-13 Memory Kit 708633-B21

HP 8GB (1x8GB) Dual Rank x8 PC3L-12800E (DDR3-1600) Unbuffered CAS-11 Low Voltage Memory Kit 713979-B21

HP 8GB (1x8GB) Dual Rank x8 PC3-14900E (DDR3-1866) Unbuffered CAS-13 Memory Kit 708635-B21

Unbuffered with ECC DIMMs (UDIMMs)

NOTE: The following memory is supported by the E5-2600 series Processors.

HP 2GB (1x2GB) Single Rank x8 PC3-12800E (DDR3-1600) Unbuffered CAS-11 Memory Kit 669320-B21

HP 2GB (1x2GB) Single Rank x8 PC3L-10600E (DDR3-1333) Unbuffered CAS-9 Low Voltage Memory Kit 647905-B21

HP 4GB (1x4GB) Dual Rank x8 PC3-12800E (DDR3-1600) Unbuffered CAS-11 Memory Kit 669322-B21

HP 4GB (1x4GB) Dual Rank x8 PC3L-10600E (DDR3-1333) Unbuffered CAS-9 Low Voltage Memory Kit 647907-B21

HP 8GB (1x8GB) Dual Rank x8 PC3-12800E (DDR3-1600) Unbuffered CAS-11 Memory Kit 669324-B21

HP 8GB (1x8GB) Dual Rank x8 PC3L-10600E (DDR3-1333) Unbuffered CAS-9 Low Voltage Memory Kit 647909-B21

Load Reduced DIMMs (LRDIMMs)

NOTE: The following memory is supported by the E5-2600 v2 series Processors.

HP 32GB (1x32GB) Quad Rank x4 PC3-14900L (DDR3-1866) Load Reduced CAS-13 Memory Kit 708643-B21

Load Reduced DIMMs (LRDIMMs)

NOTE: The following memory is supported by the E5-2600 series Processors.

HP 32GB (1x32GB) Quad Rank x4 PC3L-10600L (DDR3-1333) Load Reduced CAS-9 Low Voltage Memory Kit 647903-B21

HyperCloud DIMMs (HDIMMs) - E5-2600 series Processors

NOTE: The following memory is supported by the E5-2600 series Processors.

HP 32GB (1x32GB) Dual Rank x4 PC3-10600H (DDR3-1333) HyperCloud CAS-9 Memory Kit 715166-B21

NOTE: All DDR3 memory option kits consist of one DIMM per kit. For detailed memory configuration rules and guidelines, please use the Online DDR3

Memory Configuration Tool: www.hp.com/go/ddr3memory-configurator.

NOTE: Kits described as LP include Low Power DIMMs. For more information on ProLiant Energy Efficient Features, see: www.hp.com/go/proliant-energy-efficient

NOTE: PC3L is a low voltage memory

HP Networking

FlexibleLOM Adapters

NOTE: Only one FlexibleLOM can be added to the server. These options are upgradeable and can be changed from the original configuration after the server is shipped.

NOTE: For 10Gb adapters, a minimum of two Gigabytes (2 GB) of server memory is required per each adapter.

HP Ethernet 1Gb 4-port 331FLR FIO Adapter 684208-B21

HP FlexFabric 10Gb 2-port 526FLR-SFP+ FIO Adapter 684219-B21

Configuration Information - Factory Integrated Models

| | |
|---|------------|
| HP Ethernet 10Gb 2-port 530FLR-SFP+ FIO Adapter | 684210-B21 |
| HP FlexFabric 10Gb 2-port 533FLR-T FIO Adapter | 700760-B21 |
| HP FlexFabric 10Gb 2-port 534FLR-SFP+ FIO Adapter | 700752-B21 |
| HP FlexFabric 10Gb 2-port 554FLR-SFP+ FIO Adapter | 684213-B21 |
| HP Ethernet 1Gb 4-port 366FLR FIO Adapter | 684217-B21 |
| HP Ethernet 10Gb 2-port 560FLR-SFP+ FIO Adapter | 684218-B21 |
| HP Ethernet 10Gb 2-port 561FLR-T FIO Adapter | 700700-B21 |
| HP Ethernet 10Gb 2-port 570FLR-SFP+ FIO Adapter | 728983-B21 |
| HP Ethernet 10Gb 2-port 570FLR-SFP+ FIO Adapter | 717492-B21 |
| HP Ethernet 10Gb 2-port 571FLR-SFP+ FIO Adapter | 728993-B21 |

NOTE: Direct Attach Cable (DAC) for copper environments or fiber transceivers and cables for fiber-optic environments must be purchased separately. Please see the related NIC QuickSpecs for Technical Specifications and additional information: www.hp.com/go/ProLiantNICs.

HP InfiniBand

| | |
|---|------------|
| HP Infiniband FDR/Ethernet 10Gb/40Gb 2-port 544FLR-QSFP Adapter | 649282-B21 |
| HP Infiniband QDR/Ethernet 10Gb 2-port 544FLR-QSFP Adapter | 649283-B21 |

NOTE: 10Gb Ethernet requires the use of the QSFP to SFP+ adapter P/N 655874-B21.

NOTE: Please see the QuickSpecs for additional information: http://h18000.www1.hp.com/products/quickspecs/13078_div/13078_div.html

HP Power Supplies

NOTE: Mixing of power supplies in the same server is not supported. All power supplies must be of the same output and efficiency rating. If non-matched power supplies are inserted, you will get errors, and operation will fail.

NOTE: Prior to making a power supply selection it is highly recommended that the HP Power Advisor is run to determine the right size power supply for your server configuration. The HP Power Advisor is located at: www.hp.com/go/hppoweradvisor.

HP Common Slot Platinum Plus Power Supply Kits

NOTE: The following Power Supplies offer 94% Efficiency and lower total harmonic distortion to save on energy costs. Common Slot Platinum Plus Power Supplies support Power Discovery Services when used with the HP Intelligent PDUs.

| | |
|--|------------|
| HP 460W Common Slot Platinum Plus Hot Plug Power Supply Kit | 656362-B21 |
| HP 750W Common Slot Platinum Plus Hot Plug Power Supply Kit | 656363-B21 |
| HP 1200W Common Slot Platinum Plus Hot Plug Power Supply Kit | 656364-B21 |

HP Common Slot Gold Power Supplies

NOTE: The following Power Supplies offer 92% Efficiency.

| | |
|--|------------|
| HP 460W Common Slot Gold Hot Plug Power Supply Kit | 503296-B21 |
| HP 750W Common Slot Gold Hot Plug Power Supply Kit | 512327-B21 |

HP Common Slot -48VDC Power Supplies

NOTE: The following Power Supplies offer 92% Efficiency.

| | |
|--|------------|
| HP 750W Common Slot -48VDC Hot Plug Power Supply Kit | 636673-B21 |
|--|------------|

NOTE: The HP 750W Common Slot -48VDC power supply does not ship with a power cable. It has been designed with a terminal block connection allowing for custom design of power cords by the user.

HP Common Slot 380VDC Power Supplies

NOTE: 94% efficiency.

Configuration Information - Factory Integrated Models

| | |
|--|------------|
| HP 1200W Common Slot 380VDC Hot Plug Power Supply Kit | 684539-B21 |
| NOTE: The 1200W Common Slot 380VDC Hot Plug Power Supply Kit does not include a power cord. | |
| HP Common Slot 277VAC Power Supplies | |
| NOTE: 94% efficiency. | |
| HP 500W Common Slot 277VAC Hot Plug Power Supply Kit | 717362-B21 |
| HP 750W Common Slot 277VAC Hot Plug Power Supply Kit | 717364-B21 |
| HP 1200W Common Slot 277VAC Hot Plug Power Supply Kit | 717359-B21 |
| NOTE: The 1200W Common Slot 277VAC Hot Plug Power Supply Kit does not include a power cord. | |
| HP Common Slot Titanium Power Supply Kits | |
| NOTE: 96% efficiency with support for HP Power Discovery Services. | |
| HP 750W Common Slot Titanium Hot Plug Power Supply Kit | 697581-B21 |
| NOTE: Option Kits for AC power supplies include the power supply and one PDU IEC cable. | |
| NOTE: HP ProLiant servers ship with an IEC-IEC power cord used for rack mounting with Power Distribution Units (PDUs). For a full list of optional HP power cords please go to www.hp.com/products/powercords | |
| NOTE: Power Specification and Technical Content for supported power supplies can be found at: http://h18000.www1.hp.com/products/quickspecs/14209_div/14209_div.html | |

Step 3: Choose Additional Factory Integratable Options (only one of the following from each list unless otherwise noted)

HP Rack Kits

NOTE: Gen8 rail kits have changed significantly from prior generation rail kits. Please take a moment to review the installation documentation that comes with the server to help you with the installation of your Gen8 server.

NOTE: Rail kits are optional for DL380p Gen8 and are no longer included standard with the server. Customers have the option to purchase their server without a rail kit. The HP 2U Gen8 Cable Management Arm is not available when using Friction Rails.

NOTE: To assist in the installation of the server into the rack, an optional installation tool is available by contacting your local services representative (p/n 695539-001).

Caution: HP recommends that a minimum of two people are required for all Rack Server installations. Please refer to your installation instructions for proper tools and number of people to use for any installation.

NOTE: See HP Rack Options in Additional Options section of this QuickSpecs for more rack kit choices.

| | |
|--|------------|
| HP 2U FIO Friction Rail Kit | 663476-B21 |
| NOTE: Kit contains non-telescoping friction rails which do not allow for in-rack serviceability. The HP Gen8 Cable Management Arm is not available when using Friction Rails. | |

HP Insight Software

| | |
|--|----------|
| HP Insight Control including 1yr 24x7 Support ProLiant ML/DL/BL-bundle Single Server FIO License | C6N36A |
| HP Insight Control including 1yr 24x7 Support ProLiant ML/DL/BL-bundle FIO Electronic License | C6N36ABE |

Configuration Information - Factory Integrated Models

| | | |
|---|---|--------|
| Converged Infrastructure Management Software | HP OneView with iLO Advanced - Server hardware required on same purchase order | |
| | HP OneView incl 3yr 24x7 Supp FIO Bundle Phys 1 Svr Lic | E5Y43A |

Step 4: Choose Additional Options for Factory Integration

NOTE: For additional options, please refer to the "Core Options and Additional Options" section below.

Core Options

NOTE: Some options may not be integrated at the factory. Contact your local sales representative for additional information.

| | | |
|--------------------------|---|------------|
| HP Unique Options | HP DL380p/560 Gen8 3 Slot PCI-E Riser Kit | 653206-B21 |
| | HP DL380p/560 Gen8 2 Slot 2x16 PCI-E Riser Kit | 653208-B21 |
| | HP DL380p Gen8 Double Wide Riser Cage Kit | 662885-B21 |
| | NOTE: Kit is required to support nVidia Q6000 double wide graphics card. | |
| | NOTE: Kit contains a power cable for the nVidia Q6000 double wide graphics card. | |
| | NOTE: The double wide riser cage kit is not supported in the 12LFF and 25SFF Configure-to-order Servers. | |
| | HP DL380p Gen8 NEBS Conversion Cage Kit | 707865-B21 |
| | NOTE: This conversion kit is only available for the 8SFF base server model. | |
| | NOTE: A NEBS conversion cage kit is required for each riser in an 8SFF base server for the server to meet NEBS and ETSI certification. | |

HP Processors

Entry Processors - E5-2600 v2 series Processors

NOTE: All support up to 1333MHz memory speeds.

| | |
|--|------------|
| HP DL380p Gen8 Intel® Xeon® E5-2609v2 (2.5GHz/4-core/10MB/80W) Processor Kit | 715222-B21 |
| HP DL380p Gen8 Intel® Xeon® E5-2603v2 (1.8GHz/4-core/10MB/80W) Processor Kit | 715223-B21 |

Base Processors - E5-2600 v2 series Processors

NOTE: All support up to 1600MHz DDR3 memory speeds.

| | |
|--|------------|
| HP DL380p Gen8 Intel® Xeon® E5-2640v2 (2.0GHz/8-core/20MB/95W) Processor Kit | 715219-B21 |
| HP DL380p Gen8 Intel® Xeon® E5-2630v2 (2.6GHz/6-core/15MB/80W) Processor Kit | 715220-B21 |
| HP DL380p Gen8 Intel® Xeon® E5-2620v2 (2.1GHz/6-core/15MB/80W) Processor Kit | 715221-B21 |
| HP DL380p Gen8 Intel® Xeon® E5-2650Lv2 (1.7GHz/10-core/25MB/70W) Processor Kit | 715229-B21 |
| HP DL380p Gen8 Intel® Xeon® E5-2630Lv2 (2.4GHz/6-core/15MB/60W) Processor Kit | 715230-B21 |

Performance Processors - E5-2600 v2 series Processors

NOTE: All support up to 1866MHz DDR3 memory speeds

| | |
|--|------------|
| HP DL380p Gen8 Intel® Xeon® E5-2697v2 (2.7GHz/12-core/30MB/130W) Processor Kit | 715224-B21 |
| HP DL380p Gen8 Intel® Xeon® E5-2695v2 (2.4GHz/12-core/30MB/115W) Processor Kit | 715225-B21 |
| HP DL380p Gen8 Intel® Xeon® E5-2690v2 (3.0GHz/10-core/25MB/130W) Processor Kit | 715214-B21 |
| HP DL380p Gen8 Intel® Xeon® E5-2680v2 (2.8GHz/10-core/25MB/115W) Processor Kit | 715215-B21 |
| HP DL380p Gen8 Intel® Xeon® E5-2670v2 (2.5GHz/10-core/25MB/115W) Processor Kit | 715216-B21 |
| HP DL380p Gen8 Intel® Xeon® E5-2667v2 (3.3GHz/8-core/25MB/130W) Processor Kit | 715226-B21 |

Core Options

| | |
|---|------------|
| HP DL380p Gen8 Intel® Xeon® E5-2660v2 (2.2GHz/10-core/25MB/95W) Processor Kit | 715217-B21 |
| HP DL380p Gen8 Intel® Xeon® E5-2650v2 (2.6GHz/8-core/20MB/95W) Processor Kit | 715218-B21 |
| HP DL380p Gen8 Intel® Xeon® E5-2643v2 (3.5GHz/6-core/25MB/130W) Processor Kit | 715227-B21 |
| HP DL380p Gen8 Intel® Xeon® E5-2637v2 (3.5GHz/4-core/15MB/130W) Processor Kit | 715228-B21 |

Entry Processors - E5-2600 series Processors

NOTE: All support up to 1066MHz memory speeds.

| | |
|---|------------|
| HP DL380p Gen8 Intel® Xeon® E5-2609 (2.40GHz/4-core/10MB/80W) Processor Kit | 662252-B21 |
| HP DL380p Gen8 Intel® Xeon® E5-2603 (1.80GHz/4-core/10MB/80W) Processor Kit | 662254-B21 |

Base Processors - E5-2600 series Processors

NOTE: All support up to 1333MHz DDR3 memory speeds.

| | |
|---|------------|
| HP DL380p Gen8 Intel® Xeon® E5-2640 (2.5GHz/6-core/15MB/95W) Processor Kit | 662246-B21 |
| HP DL380p Gen8 Intel® Xeon® E5-2630 (2.3GHz/6-core/15MB/95W) Processor Kit | 662248-B21 |
| HP DL380p Gen8 Intel® Xeon® E5-2620 (2.0GHz/6-core/15MB/95W) Processor Kit | 662250-B21 |
| HP DL380p Gen8 Intel® Xeon® E5-2630L (2.0GHz/6-core/15MB/60W) Processor Kit | 675092-B21 |

Performance Processors - E5-2600 series Processors

NOTE: All support up to 1600MHz DDR3 memory speeds.

| | |
|---|------------|
| HP DL380p Gen8 Intel® Xeon® E5-2690 (2.9GHz/8-core/20MB/135W) Processor Kit | 662226-B21 |
| HP DL380p Gen8 Intel® Xeon® E5-2680 (2.7GHz/8-core/20MB/130W) Processor Kit | 662228-B21 |
| HP DL380p Gen8 Intel® Xeon® E5-2670 (2.6GHz/8-core/20MB/115W) Processor Kit | 662240-B21 |
| HP DL380p Gen8 Intel® Xeon® E5-2667 (2.9GHz/6-core/15MB/130W) Processor Kit | 662214-B21 |
| HP DL380p Gen8 Intel® Xeon® E5-2665 (2.4GHz/8-core/20MB/115W) Processor Kit | 666509-B21 |
| HP DL380p Gen8 Intel® Xeon® E5-2660 (2.2GHz/8-core/20MB/95W) Processor Kit | 662242-B21 |
| HP DL380p Gen8 Intel® Xeon® E5-2650 (2.0GHz/8-core/20MB/95W) Processor Kit | 662244-B21 |
| HP DL380p Gen8 Intel® Xeon® E5-2650L (1.8GHz/8-core/20MB/70W) Processor Kit | 662256-B21 |
| HP DL380p Gen8 Intel® Xeon® E5-2643 (3.3GHz/4-core/10MB/130W) Processor Kit | 662216-B21 |
| HP DL380p Gen8 Intel® Xeon® E5-2637 (3.0GHz/2-core/5MB/80W) Processor Kit | 662224-B21 |

NOTE: Up to 2 processors supported. Performance and Energy Star Model configurations include two processors.

Core Options

NOTE: HT indicates that the processor model supports Intel® Hyper-Threading Technology

NOTE: Turbo2: Intel® Turbo Boost Technology 2.0 provides more computing power when you need it with performance that adapts to spikes in your workload and delivers more performance upside than then previous generation turbo technology.

NOTE: DDR3 speed is the maximum memory speed of the processor. Actual memory speed may depend on the quantity and type of DIMMs installed.

HP Memory

NOTE: HP memory from previous generation servers are not qualified or warranted with this HP ProLiant Server. HP SmartMemory is required to realize the memory performance improvements and enhanced functionality listed in this document for Gen8. For additional information, please see the HP SmartMemory QuickSpecs at:

http://h18000.www1.hp.com/products/quickspecs/14225_div/14225_div.html

NOTE: LRDIMM, RDIMM, UDIMM, and HDIMMs are all distinct memory technologies and cannot be mixed within a server. The majority of ProLiant Gen8 servers support LRDIMM, RDIMM and UDIMMs.

Registered DIMMs (RDIMMs)

NOTE: The following memory is supported by the E5-2600 v2 series Processors.

| | |
|--|------------|
| HP 4GB (1x4GB) Single Rank x4 PC3L-12800R (DDR3-1600) Registered CAS-11 Low Voltage Memory Kit | 713981-B21 |
| HP 4GB (1x4GB) Single Rank x4 PC3-14900R (DDR3-1866) Registered CAS-13 Memory Kit | 708637-B21 |
| HP 8GB (1x8GB) Dual Rank x4 PC3L-12800R (DDR3-1600) Registered CAS-11 Low Voltage Memory Kit | 713983-B21 |
| HP 8GB (1x8GB) Single Rank x4 PC3L-12800R (DDR3-1600) Registered CAS-11 Low Voltage Memory Kit | 731765-B21 |
| HP 8GB (1x8GB) Dual Rank x4 PC3-14900R (DDR3-1866) Registered CAS-13 Memory Kit | 708639-B21 |
| HP 8GB (1x8GB) Single Rank x4 PC3-14900R (DDR3-1866) Registered CAS-13 Memory Kit | 731761-B21 |
| HP 16GB (1x16GB) Dual Rank x4 PC3L-12800R (DDR3-1600) Registered CAS-11 Low Voltage Memory Kit | 713985-B21 |
| HP 16GB (1x16GB) Dual Rank x4 PC3-14900R (DDR3-1866) Registered CAS-13 Memory Kit | 708641-B21 |

Registered DIMMs (RDIMMs)

NOTE: The following memory is supported by the E5-2600 series Processors.

| | |
|---|------------|
| HP 4GB (1x4GB) Single Rank x4 PC3L-10600R (DDR3-1333) Registered CAS-9 Low Voltage Memory Kit | 647893-B21 |
| HP 4GB (1x4GB) Single Rank x4 PC3-12800R (DDR3-1600) Registered CAS-11 Memory Kit | 647895-B21 |
| HP 8GB (1x8GB) Dual Rank x4 PC3L-10600R (DDR3-1333) Registered CAS-9 Low Voltage Memory Kit | 647897-B21 |
| HP 8GB (1x8GB) Single Rank x4 PC3-12800R (DDR3-1600) Registered CAS-11 Memory Kit | 647899-B21 |
| HP 8GB (1x8GB) Dual Rank x4 PC3-12800R (DDR3-1600) Registered CAS-11 Memory Kit | 690802-B21 |

Core Options

HP 16GB (1x16GB) Dual Rank x4 PC3L-10600R (DDR3-1333) Registered CAS-9 Low Voltage Memory Kit 647901-B21

HP 16GB (1x16GB) Dual Rank x4 PC3-12800R (DDR3-1600) Registered CAS-11 Memory Kit 672631-B21

Unbuffered with ECC DIMMs (UDIMMs)

NOTE: The following memory is supported by the E5-2600 v2 series Processors.

HP 2GB (1x2GB) Single Rank x8 PC3L-12800E (DDR3-1600) Unbuffered CAS-11 Low Voltage Memory Kit 713975-B21

HP 2GB (1x2GB) Single Rank x8 PC3-14900E (DDR3-1866) Unbuffered CAS-13 Memory Kit 708631-B21

HP 4GB (1x4GB) Dual Rank x8 PC3L-12800E (DDR3-1600) Unbuffered CAS-11 Low Voltage Memory Kit 713977-B21

HP 4GB (1x4GB) Dual Rank x8 PC3-14900E (DDR3-1866) Unbuffered CAS-13 Memory Kit 708633-B21

HP 8GB (1x8GB) Dual Rank x8 PC3L-12800E (DDR3-1600) Unbuffered CAS-11 Low Voltage Memory Kit 713979-B21

HP 8GB (1x8GB) Dual Rank x8 PC3-14900E (DDR3-1866) Unbuffered CAS-13 Memory Kit 708635-B21

Unbuffered with ECC DIMMs (UDIMMs)

NOTE: The following memory is supported by the E5-2600 series Processors.

HP 2GB (1x2GB) Single Rank x8 PC3-12800E (DDR3-1600) Unbuffered CAS-11 Memory Kit 669320-B21

HP 2GB (1x2GB) Single Rank x8 PC3L-10600E (DDR3-1333) Unbuffered CAS-9 Low Voltage Memory Kit 647905-B21

HP 4GB (1x4GB) Dual Rank x8 PC3-12800E (DDR3-1600) Unbuffered CAS-11 Memory Kit 669322-B21

HP 4GB (1x4GB) Dual Rank x8 PC3L-10600E (DDR3-1333) Unbuffered CAS-9 Low Voltage Memory Kit 647907-B21

HP 8GB (1x8GB) Dual Rank x8 PC3-12800E (DDR3-1600) Unbuffered CAS-11 Memory Kit 669324-B21

HP 8GB (1x8GB) Dual Rank x8 PC3L-10600E (DDR3-1333) Unbuffered CAS-9 Low Voltage Memory Kit 647909-B21

Load Reduced DIMMs (LRDIMMs)

NOTE: The following memory is supported by the E5-2600 v2 series Processors.

HP 32GB (1x32GB) Quad Rank x4 PC3-14900L (DDR3-1866) Load Reduced CAS-13 Memory Kit 708643-B21

Load Reduced DIMMs (LRDIMMs)

NOTE: The following memory is supported by the E5-2600 series Processors.

HP 32GB (1x32GB) Quad Rank x4 PC3L-10600L (DDR3-1333) Load Reduced CAS-9 Low Voltage Memory Kit 647903-B21

HyperCloud DIMMs (HDIMMs)

NOTE: The following memory is supported by the E5-2600 series Processors.

HP 32GB (1x32GB) Dual Rank x4 PC3-10600H (DDR3-1333) HyperCloud CAS-9 Memory Kit 715166-B21

NOTE: All DDR3 memory option kits consist of one DIMM per kit. For detailed memory configuration rules and guidelines, please use the Online DDR3 Memory Configuration Tool: www.hp.com/go/ddr3memory-configurator.

NOTE: Depending on the memory configuration and processor model, 1600MHz

Core Options

and 1333MHz memory may operate at a lower speed. Please see the see the "Memory" section later in this document and the Online Memory Configuration Tool for details at: www.hp.com/go/ddr3memory-configurator.

NOTE: For additional memory rules and guidelines, see the "Memory" section later in this document.

NOTE: For more information on ProLiant Energy Efficient Features, see:

www.hp.com/go/proliant-energy-efficient

NOTE: PC3L is a low voltage memory.

| | | |
|--------------------------|---|------------|
| HP Optical Drives | HP 12.7mm Slim SATA DVD-ROM JackBlack Optical Drive | 652232-B21 |
| | HP 12.7mm Slim SATA DVD-RW JackBlack Optical Drive | 652235-B21 |

HP Hard Drives

NOTE: The HP ProLiant DL380p Gen8 Smart Storage solutions are equipped with entirely re-designed Small Form Factor (SFF 2.5 in) and Large Form Factor (LFF 3.5 in) hot plug carriers for HP Qualified Hard Drives and Solid State Drives. These new carriers provide status and activity indicators as well as caution indicators for "Do Not Remove".

NOTE: The components of a storage subsystem (e.g. the drive, the

HBA/controller, firmware, and the server backplane) should operate at the same data transfer rate or the system bandwidth will be negotiated down to an acceptable level for all components.

NOTE: Hard drives have either a one year or three year warranty; refer to the specific hard drive QuickSpecs for details.

SAS Hot Plug with SmartDrive SFF (2.5-inch) Enterprise Drives

| | |
|--|------------|
| HP 1.2TB 6G SAS 10K rpm SFF (2.5-inch) SC Enterprise 3yr Warranty Hard Drive | 697574-B21 |
|--|------------|

| | |
|--|------------|
| HP 900GB 6G SAS 10K rpm SFF (2.5-inch) SC Enterprise 3yr Warranty Hard Drive | 652589-B21 |
|--|------------|

| | |
|--|------------|
| HP 600GB 6G SAS 10K rpm SFF (2.5-inch) SC Enterprise 3yr Warranty Hard Drive | 652583-B21 |
|--|------------|

| | |
|--|------------|
| HP 450GB 6G SAS 10K rpm SFF (2.5-inch) SC Enterprise 3yr Warranty Hard Drive | 652572-B21 |
|--|------------|

| | |
|--|------------|
| HP 300GB 6G SAS 10K rpm SFF (2.5-inch) SC Enterprise 3yr Warranty Hard Drive | 652564-B21 |
|--|------------|

| | |
|--|------------|
| HP 300GB 6G SAS 15K rpm SFF (2.5-inch) SC Enterprise 3yr Warranty Hard Drive | 652611-B21 |
|--|------------|

| | |
|--|------------|
| HP 146GB 6G SAS 15K rpm SFF (2.5-inch) SC Enterprise 3yr Warranty Hard Drive | 652605-B21 |
|--|------------|

SAS Hot Plug SmartDrive SFF (2.5-inch) Midline Drives

| | |
|--|------------|
| HP 1TB 6G SAS 7.2K rpm SFF (2.5-inch) SC Midline 1yr Warranty Hard Drive | 652749-B21 |
|--|------------|

| | |
|--|------------|
| HP 500GB 6G SAS 7.2K rpm SFF (2.5-inch) SC Midline 1yr Warranty Hard Drive | 652745-B21 |
|--|------------|

SAS Hot Plug SmartDrive LFF (3.5-inch) Enterprise Drives

| | |
|--|------------|
| HP 600GB 6G SAS 15K rpm LFF (3.5-inch) SC Enterprise 3yr Warranty Hard Drive | 652620-B21 |
|--|------------|

| | |
|--|------------|
| HP 450GB 6G SAS 15K rpm LFF (3.5-inch) SC Enterprise 3yr Warranty Hard Drive | 652615-B21 |
|--|------------|

SAS Hot Plug SmartDrive LFF (3.5-inch) Midline Drives

Core Options

| | |
|--|------------|
| HP 4TB 6G SAS 7.2K rpm LFF (3.5-inch) SC Midline 1yr Warranty Hard Drive | 695510-B21 |
| HP 3TB 6G SAS 7.2K rpm LFF (3.5-inch) SC Midline 1yr Warranty Hard Drive | 652766-B21 |
| HP 2TB 6G SAS 7.2K rpm LFF (3.5-inch) SC Midline 1yr Warranty Hard Drive | 652757-B21 |
| HP 1TB 6G SAS 7.2K rpm LFF (3.5-inch) SC Midline 1yr Warranty Hard Drive | 652753-B21 |

NOTE: Please see the QuickSpecs for Technical Specifications and additional information:

http://h18000.www1.hp.com/products/quickspecs/12244_div/12244_div.html
(Worldwide)

6G SATA Hot Plug with SmartDrive SFF (2.5-inch) Midline (MDL) Drives

| | |
|---|------------|
| HP 1TB 6G SATA 7.2K rpm SFF (2.5-inch) SC Midline 1yr Warranty Hard Drive | 655710-B21 |
| HP 500GB 6G SATA 7.2K rpm SFF (2.5-inch) SC Midline 1yr Warranty Hard Drive | 655708-B21 |

6G SATA Hot Plug with SmartDrive LFF (3.5-inch) Midline (MDL) Drives

| | |
|---|------------|
| HP 4TB 6G SATA 7.2k rpm LFF (3.5-inch) SC Midline 1yr Warranty Hard Drive | 693687-B21 |
| HP 3TB 6G SATA 7.2K rpm LFF (3.5-inch) SC Midline 1yr Warranty Hard Drive | 628061-B21 |
| HP 2TB 6G SATA 7.2K rpm LFF (3.5-inch) SC Midline 1yr Warranty Hard Drive | 658079-B21 |
| HP 1TB 6G SATA 7.2K rpm LFF (3.5-inch) SC Midline 1yr Warranty Hard Drive | 657750-B21 |
| HP 500GB 6G SATA 7.2K rpm LFF (3.5-inch) SC Midline 1yr Warranty Hard Drive | 658071-B21 |

NOTE: Please see the QuickSpecs for Technical Specifications and additional information:

http://h18000.www1.hp.com/products/quickspecs/13021_div/13021_div.html
(Worldwide)

6G SATA Value Endurance Hot Plug SFF (2.5-inch) Enterprise Boot Solid State Drives

| | |
|--|------------|
| HP 120GB 6G SATA Value Endurance SFF 2.5-in SC Enterprise Boot 3yr Wty Solid State Drive | 717965-B21 |
| HP 80GB 6G SATA Value Endurance SFF 2.5-in SC Enterprise Boot 3yr Wty Solid State Drive | 734360-B21 |

6G SATA Value Endurance Hot Plug LFF (3.5-inch) Enterprise Boot Solid State Drives

| | |
|--|------------|
| HP 120GB 6G SATA Value Endurance LFF 3.5-in SC Enterprise Boot 3yr Wty Solid State Drive | 718171-B21 |
| HP 80GB 6G SATA Value Endurance LFF 3.5-in SC Enterprise Boot 3yr Wty Solid State Drive | 734362-B21 |

6G SATA Value Endurance Hot Plug SFF (2.5-inch) Enterprise Value Solid State Drives

| | |
|---|------------|
| HP 800GB 6G SATA Value Endurance SFF 2.5-in SC Enterprise Value 3yr Wty Solid State Drive | 717973-B21 |
| HP 480GB 6G SATA Value Endurance SFF 2.5-in SC Enterprise Value 3yr Wty Solid State Drive | 717971-B21 |
| HP 600GB 6G SATA Value Endurance SFF 2.5-in SC Enterprise Boot 3yr Wty Solid State Drive | 739898-B21 |
| HP 300GB 6G SATA Value Endurance SFF 2.5-in SC Enterprise Boot 3yr Wty Solid State Drive | 739888-B21 |
| HP 240GB 6G SATA Value Endurance SFF 2.5-in SC Enterprise Value 3yr Wty Solid State Drive | 717969-B21 |

6G SATA Value Endurance Hot Plug LFF (3.5-inch) Enterprise Value Solid State Drives

Core Options

| | |
|---|------------|
| HP 800GB 6G SATA Value Endurance LFF 3.5-in SC Enterprise Value 3yr Wty Solid State Drive | 718189-B21 |
| HP 600GB 6G SATA Value Endurance LFF 3.5-in SC Enterprise Boot 3yr Wty Solid State Drive | 739900-B21 |
| HP 480GB 6G SATA Value Endurance LFF 3.5-in SC Enterprise Value 3yr Wty Solid State Drive | 718183-B21 |
| HP 300GB 6G SATA Value Endurance LFF 3.5-in SC Enterprise Boot 3yr Wty Solid State Drive | 739890-B21 |
| HP 240GB 6G SATA Value Endurance LFF 3.5-in SC Enterprise Value 3yr Wty Solid State Drive | 718177-B21 |
| 6G SATA ME Hot Plug SFF (2.5-inch) Enterprise Mainstream Solid State Drives | |
| HP 800GB 6G SATA Mainstream Endurance SFF 2.5-in SC Enterprise Mainstream 3yr Wty Solid State Drive | 691868-B21 |
| HP 400GB 6G SATA Mainstream Endurance SFF 2.5-in SC Enterprise Mainstream 3yr Wty Solid State Drive | 691866-B21 |
| HP 200GB 6G SATA Mainstream Endurance SFF 2.5-in SC Enterprise Mainstream 3yr Wty Solid State Drive | 691864-B21 |
| HP 100GB 6G SATA Mainstream Endurance SFF 2.5-in SC Enterprise Mainstream 3yr Wty Solid State Drive | 691862-B21 |
| 6G SATA ME Hot Plug SFF (3.5-inch) Enterprise Mainstream Solid State Drives | |
| HP 800GB 6G SATA Mainstream Endurance LFF 3.5-in SC Enterprise Mainstream 3yr Wty Solid State Drive | 691860-B21 |
| HP 400GB 6G SATA Mainstream Endurance LFF 3.5-in SC Enterprise Mainstream 3yr Wty Solid State Drive | 691856-B21 |
| HP 200GB 6G SATA Mainstream Endurance LFF 3.5-in SC Enterprise Mainstream 3yr Wty Solid State Drive | 691854-B21 |
| HP 100GB 6G SATA Mainstream Endurance LFF 3.5-in SC Enterprise Mainstream 3yr Wty Solid State Drive | 691852-B21 |
| 6G SAS SLC Hot Plug SFF (2.5-inch) Enterprise Performance Solid State Drives | |
| HP 400GB 6G SAS SLC SFF (2.5-inch) SC Enterprise Performance 3yr Warranty Solid State Drive | 653082-B21 |
| HP 200GB 6G SAS SLC SFF (2.5-inch) SC Enterprise Performance 3yr Warranty Solid State Drive | 653078-B21 |
| NOTE: Please see the QuickSpecs for Technical Specifications and additional information: http://h18000.www1.hp.com/products/quickspecs/14038_div/14038_div.html (Worldwide) | |
| Hard Drive Kits | |
| NOTE: All Factory Integrated Models will be populated with sufficient hard drive blanks based on the number of initial hard drives ordered with the server. | |
| NOTE: The part numbers for single HDD blanks below are provided should the customer require replacement HDD blanks for their server. | |
| HP SFF Gen8 Hard Drive Blank Kit | 666987-B21 |
| HP LFF Gen8 Hard Drive Blank Kit | 666986-B21 |
| HP DL380/DL385 Gen8 8 Small Form Factor Hard Drive Backplane Cage Kit | 662883-B21 |

Core Options

NOTE: With upgrade of 8SFF Cage/Bkpln (662883-B21), there is no Optical Drive support.

NOTE: All cables necessary for proper installation of the 8SFF Cage are included with this Kit.

NOTE: With upgrade of 8SFF Cage/Bkpln (662883-B21), an additional storage controller is required. HP recommends the HP Smart Array P420/1GB FBWC 6Gb 2-ports Int SAS Controller (P/N 631670-B21).

NOTE: The P822 controller has only two internal ports like the P420 controller and cannot be used to attach both 8SFF drive cages through a single controller. Please see the QuickSpecs for Technical Specifications and additional information:

http://h18000.www1.hp.com/products/quickspecs/14341_div/14341_div.html

NOTE: In Gen8, the 8+8SFF solution is designed as a performance configuration delivering maximum IOPS across the two drive cages. Customers seeking to have all drives in a single volume should consider the DL380p Gen8 25 SFF Configure-to-order Server (P/N 665554-B21) as a base.

Hard Drive Cables

| | |
|---|------------|
| HP DL38x/DL360 Gen8 Embedded SATA Cable Kit | 664009-B21 |
|---|------------|

HP Networking

Gigabit Ethernet adapters

| | |
|--|------------|
| HP NC112T PCI Express Gigabit Server Adapter | 503746-B21 |
| HP NC365T 4-port Ethernet Server Adapter | 593722-B21 |
| HP Ethernet 1Gb 4-port 331T Adapter | 647594-B21 |
| HP Ethernet 1Gb 2-port 361T Adapter | 652497-B21 |
| HP Ethernet 1Gb 2-port 332T Adapter | 615732-B21 |

10 Gigabit Ethernet Adapters

NOTE: A minimum of two Gigabytes (2 GB) of server memory is required per each adapter.

NOTE: Direct Attach Cable (DAC) for copper environments or fiber transceivers and cables for fiber-optic environments must be purchased separately. Please see the related NIC QuickSpecs for Technical Specifications and additional information: www.hp.com/go/ProLiantNICs.

| | |
|---|------------|
| HP NC523SFP 10Gb 2-port Server Adapter | 593717-B21 |
| HP Ethernet 10Gb 2-port 530SFP Adapter | 652503-B21 |
| HP Ethernet 10Gb 2-port 530T Adapter | 656596-B21 |
| HP Ethernet 10Gb 2-port 560SFP+ Adapter | 665249-B21 |
| HP Ethernet 10Gb 2-port 561T Adapter | 716591-B21 |
| HP NC552SFP 10Gb 2-port Ethernet Server Adapter | 614203-B21 |
| HP Ethernet 10Gb 2-port 570SFP+ Adapter | 718904-B21 |
| HP Ethernet 10Gb 2-port 571SFP+ Adapter | 728987-B21 |
| HP 10 GbE PCI-e G2 Dual Port Network Interface Card | 516937-B21 |

FlexibleLOM Adapters

NOTE: Only one FlexibleLOM can be added to the server. These options are upgradeable and can be changed from the original configuration after the server is shipped.

NOTE: Direct Attach Cable (DAC) for copper environments or fiber transceivers and cables for fiber-optic environments must be purchased separately. Please see the related NIC QuickSpecs for Technical Specifications and additional

Core Options

information: www.hp.com/go/ProLiantNICs.

| | |
|---|------------|
| HP Ethernet 1Gb 4-port 331FLR Adapter | 629135-B21 |
| HP Ethernet 1Gb 4-port 366FLR Adapter | 665240-B21 |
| HP FlexFabric 10Gb 2-port 526FLR-SFP+ Adapter | 629138-B21 |
| HP Ethernet 10Gb 2-port 530FLR-SFP+ Adapter | 647581-B21 |
| HP FlexFabric 10Gb 2-port 533FLR-T Adapter | 700759-B21 |
| HP FlexFabric 10Gb 2-port 534FLR-SFP+ Adapter | 700751-B21 |
| HP FlexFabric 10Gb 2-port 554FLR-SFP+ Adapter | 629142-B21 |
| HP Ethernet 10Gb 2-port 560FLR-SFP+ Adapter | 665243-B21 |
| HP Ethernet 10Gb 2-port 561FLR-T Adapter | 700699-B21 |
| HP Ethernet 10Gb 2-port 570FLR-SFP+ Adapter | 717491-B21 |
| HP Ethernet 10Gb 2-port 571FLR-SFP+ Adapter | 728992-B21 |

NOTE: Please see the QuickSpecs for Technical Specifications and additional information: www.hp.com/go/ProLiantNICs

HP InfiniBand

| | |
|---|------------|
| QLogic InfiniBand 4X QDR PCI-E G2 Dual Port HCA | 583211-B21 |
| HP InfiniBand 4X QDR ConnectX-2 PCIe G2 Dual Port HCA | 592520-B21 |
| HP Infiniband FDR/Ethernet 10Gb/40Gb 2-port 544QSFP Adapter | 649281-B21 |

NOTE: For the following two InfiniBand Adapters, only 1 FlexibleLOM can be added to the server, which is selected in Step 2 for the "Configuration Information - Factory Integrated Models" section. These two options are for upgrade or change from original configuration.

NOTE: FLR Indicates new HP FlexibleLOM Adapter series.

| | |
|---|------------|
| HP Infiniband FDR/Ethernet 10Gb/40Gb 2-port 544FLR-QSFP Adapter | 649282-B21 |
| HP Infiniband QDR/Ethernet 10Gb 2-port 544FLR-QSFP Adapter | 649283-B21 |

NOTE: 10Gb Ethernet requires the use of the QSFP to SFP+ adapter P/N 655874-B21.

NOTE: Please see the QuickSpecs for additional information: http://h18000.www1.hp.com/products/quickspecs/13078_div/13078_div.html

HP I/O Expansion Options

| | |
|--|------------|
| HP DL380p/560 Gen8 3 Slot PCI-E Riser Kit | 653206-B21 |
| HP DL380p/560 Gen8 2 Slot 2x16 PCI-E Riser Kit | 653208-B21 |
| HP DL380p Gen8 Double Wide Riser Cage Kit | 662885-B21 |

NOTE: Kit is required to support nVidia Q6000 double wide graphics card.

NOTE: Kit contains a power cable for the nVidia Q6000 double wide graphics card.

NOTE: The double wide riser cage kit is not supported in the 12LFF and 25SFF Configure-to-order Servers.

| | |
|---|------------|
| HP DL380p Gen8 NEBS Conversion Cage Kit | 707865-B21 |
|---|------------|

NOTE: This conversion kit is only available for the 8SFF base server model.

NOTE: A NEBS conversion cage kit is required for each riser in an 8SFF base server for the server to meet NEBS and ETSI certification.

HP Power Supplies

NOTE: Mixing of power supplies in the same server is not supported. All power supplies must be of the same output and efficiency rating. If non-matched power

Core Options

supplies are inserted, you will get errors, and operation will fail.

NOTE: Prior to making a power supply selection it is highly recommended that the HP Power Advisor is run to determine the right size power supply for your server configuration. The HP Power Advisor is located at:

www.hp.com/go/hppoweradvisor.

HP Common Slot Platinum Plus Power Supply Kits

NOTE: The following Power Supplies offer 94% Efficiency with support for Intelligent Power Discovery.*

HP 460W Common Slot Platinum Plus Hot Plug Power Supply Kit 656362-B21

HP 750W Common Slot Platinum Plus Hot Plug Power Supply Kit 656363-B21

HP 1200W Common Slot Platinum Plus Hot Plug Power Supply Kit 656364-B21

HP Common Slot Gold Power Supplies

NOTE: The following Power Supplies offer 92% Efficiency.

HP 460W Common Slot Gold Hot Plug Power Supply Kit 503296-B21

HP 750W Common Slot Gold Hot Plug Power Supply Kit 512327-B21

HP Common Slot -48VDC Power Supplies

NOTE: The following Power Supplies offer 92% Efficiency.

HP 750W Common Slot -48VDC Hot Plug Power Supply Kit 636673-B21

NOTE: The 750W Common Slot -48VDC Hot Plug Power Supply Kit does not include a power cord. It has been designed with a terminal block connection that allows for custom design of power cords by the end user. To select an alternative power cord for your server, please review the HP Common Slot Power Supplies QuickSpecs

HP Common Slot 380VDC Power Supplies

NOTE: 94% efficiency.

HP 1200W Common Slot 380VDC Hot Plug Power Supply Kit 684539-B21

NOTE: The 1200W Common Slot 380VDC Hot Plug Power Supply Kit does not include a power cord.

HP Common Slot 277VAC Power Supplies

NOTE: 94% efficiency.

HP 500W Common Slot 277VAC Hot Plug Power Supply Kit 717362-B21

HP 750W Common Slot 277VAC Hot Plug Power Supply Kit 717364-B21

HP 1200W Common Slot 277VAC Hot Plug Power Supply Kit 717359-B21

NOTE: The 1200W Common Slot 277VAC Hot Plug Power Supply Kit does not include a power cord.

HP Common Slot Titanium Power Supply Kits

NOTE: 96% efficiency with support for HP Power Discovery Services.

HP 750W Common Slot Titanium Hot Plug Power Supply Kit 697581-B21

NOTE: Option Kits contain optional power supply, an IEC power cable and PDU IEC cables.

NOTE: HP ProLiant servers ship with an IEC-IEC power cord used for rack mounting with Power Distribution Units (PDUs). For a full list of optional HP power cords please go to: www.hp.com/products/powercords

NOTE: Power Specification and Technical Content for supported power supplies can be found at:

http://h18000.www1.hp.com/products/quickspecs/14209_div/14209_div.html

Core Options

| | | |
|---------------------------|---|------------|
| HP Graphic Options | HP 150W PCI-E Power Cable Kit | 669777-B21 |
| | HP 225W PCIe Power Cable Kit | 728539-B21 |
| | NVIDIA Quadro 4000 2GB PCI-E Adapter | 655933-B21 |
| | NOTE: The DL380p Gen8 can support up to two Quadro 4000 cards. One card in each x16 slot in riser 1 and riser 2. Riser 2 function requires a second processor. | |
| | NOTE: Each Quadro 4000 card requires a 150W PCI-E Power Cable Kit (P/N 669777-B21). | |
| | NOTE: The Quadro 4000 option kit is not supported in the 12LFF and 25SFF Configure-to-order Servers. | |
| | NVIDIA Quadro 6000 6GB PCI-E Adapter | 655935-B21 |
| | NOTE: The DL380p Gen8 can support one Quadro 6000 card in a x16 slot in riser 2. Riser 2 function requires a second processor. | |
| | NOTE: Installation of the Quadro 6000 requires selection of the HP DL380p Gen8 Double Wide Graphics Riser Cage Kit (P/N 662885-B21). This riser kit includes a power cable along with the riser. | |
| | NOTE: The Quadro 6000 option kit is not supported in the 12LFF and 25SFF Configure-to-order Servers. | |

Additional Options

NOTE: Some options may not be integrated at the factory. To ensure only valid configurations are ordered, HP recommends the use of an HP approved configurator. Contact your local sales representative for additional information.

| HP Insight Software | HP Insight Control | |
|----------------------------|---|------------|
| | HP Insight Control including 1yr 24x7 Technical Support and Updates Single Server License | C6N27A |
| | HP Insight Control including 1yr 24x7 Technical Support and Updates Electronic License | C6N28ABE |
| | HP Insight Control Server Provisioning Media Kit | BD883A |
| | HP Insight Management Media Kit | C6N31A |
| | HP Insight Control Server Deployment including 1yr 24x7 Support Electronic License | T9082AAE |
| | HP Insight Control Server Deployment including 1yr 24x7 Support Single Server License | 452151-B21 |

NOTE: Electronic and Flexible-Quantity licenses can be used to purchase multiple licenses with a single activation key.

NOTE: Customer will receive a license entitlement certificate. The license entitlement certificate must be redeemed online or via fax in order to obtain the license activation key(s). Includes one year of 24 x 7 HP Software Technical Support and Update Service.

NOTE: Licenses ship without media. The HP Insight Control Media Kit can be ordered separately, or can be downloaded at:

<http://www.hp.com/go/insightupdates>.

NOTE: For additional license options please see the QuickSpecs at:

http://h18000.www1.hp.com/products/quickspecs/12631_div/12631_div.html

HP Integrated Lights-Out (iLO) Advanced for ProLiant

| | | |
|--|--|------------|
| | HP iLO Advanced including 1yr 24x7 Technical Support and Updates Electronic License | E6U59ABE |
| | HP iLO Advanced including 3yr 24x7 Tech Support and Updates Electronic License | E6U64ABE |
| | HP iLO Advanced including 1yr 24x7 Technical Support and Updates Single Server License | 512485-B21 |
| | HP iLO Advanced 1 Server License with 3yr 24x7 Tech Support and Updates | BD505A |

NOTE: For additional license options please see the QuickSpecs at:

http://h18004.www1.hp.com/products/quickspecs/14276_div/14276_div.html

NOTE: For more information, visit: <http://www.hp.com/go/ilo>

Additional Options

Converged Infrastructure Management Software

HP OneView

HP OneView with iLO Advanced

HP OneView incl 3yr 24x7 Supp Phys 1 Svr Lic

E5Y34A

HP OneView Media Kit Phys No Lic

E5Y37A

HP OneView without iLO Advanced

HP OneView w/o iLO Adv incl 3yr 24x7 Supp Phys 1 Svr Lic

E5Y38A

NOTE: Please see the QuickSpecs for Technical Specifications and additional information:

http://h18000.www1.hp.com/products/quickspecs/14621_div/14621_div.html
(Worldwide)

High Performance Clusters

HP Cluster Management Utility

HP Insight Cluster Management Utility 1yr 24x7 Flexible License

QL803B

HP Insight Cluster Management Utility 3yr 24x7 Flexible License

BD476A

NOTE: These part numbers can be used to purchase one certificate for multiple licenses and support with a single activation key. Each license is for one node (server). Customer will receive a printed end user license agreement and license entitlement certificate via physical shipment. The license entitlement certificate must be redeemed online in order to obtain a license key. Customer also will receive a support agreement.

HP Insight Cluster Management Utility Media

BD477A

NOTE: For additional license kits please see the QuickSpecs at:

http://h18004.www1.hp.com/products/quickspecs/12612_div/12612_div.html

HP I/O Accelerator Options

Second Generation Accelerators

HP 365GB Multi Level Cell G2 PCIe ioDrive2 for ProLiant Servers

673642-B21

HP 785GB Multi Level Cell G2 PCIe ioDrive2 for ProLiant Servers

673644-B21

HP 1205GB Multi Level Cell G2 PCIe ioDrive2 for ProLiant Servers

673646-B21

HP 2410GB Multi Level Cell G2 PCIe ioDrive2 Duo for ProLiant Servers

673648-B21

HP 3TB G2 FH/HL PCIe ioDrive2 IO Accelerator for ProLiant Servers

721458-B21

NOTE: Please see the QuickSpecs for Technical Specifications and additional information:

http://h18000.www1.hp.com/products/quickspecs/13587_div/13587_div.html
(Worldwide)

HP PCIe Workload Accelerator Options

Mainstream Endurance (ME) PCIe Workload Accelerators

HP 1.4TB HH/HL Mainstream Endurance (ME) PCIe Workload Accelerator

729307-B21

HP 700GB HH/HL Mainstream Endurance (ME) PCIe Workload Accelerator

729305-B21

High Endurance (HE) PCIe Workload Accelerators

HP 350GB HH/HL PCIe Workload Accelerator for ProLiant Servers

708088-B21

HP 700GB HH/HL PCIe Workload Accelerator for ProLiant Servers

708090-B21

NOTE: Please see the QuickSpecs for Technical Specifications and additional information:

http://h18000.www1.hp.com/products/quickspecs/14528_div/14528_div.html
(Worldwide)

Additional Options

| | | |
|--------------------|---|------------|
| HP Security | HP Trusted Platform Module Option | 488069-B21 |
| | <p>NOTE: The TPM (Trusted Platform Module) is a microcontroller chip that can securely store artifacts used to authenticate the server platform. These artifacts can include passwords, certificates and encryption keys. Windows® BitLocker™ Drive Encryption (BitLocker) is a data protection feature available in Windows Server® 2008. BitLocker leverages the enhanced security capabilities of a Trusted Platform Module (TPM) version 1.2. The TPM works with BitLocker to help protect user data and to ensure that a server running Windows Server 2008 has not been tampered with while the system was offline. For more information about TPM, including a white paper, go to: www.hp.com/go/TPM.</p> <p>NOTE: ProLiant OS pre-installed units will come with the partition required for TPM deployment.</p> <p>NOTE: The TPM key is unique to every TPM deployed server and must be retained. Misplacing or losing the key could result in data loss.</p> | |
| | HP 2U Security Bezel Kit | 666988-B21 |

HP Storage Controllers SAS Controllers

Smart Array P222 Controller

NOTE: P222 requires (1) HP Mini SAS Straight to Straight 37in Cable Assembly (P/N 662897-B21)

HP Smart Array P222/512 FBWC 6Gb 1-port Int/1-port Ext SAS Controller 631667-B21

Smart Array P420 Controller

NOTE: P420 requires (2) HP Mini SAS Straight to Straight 37in Cable Assemblies (P/N 662897-B21)

HP Smart Array P420/1GB FBWC 6Gb 2-ports Int SAS Controller 631670-B21

HP Smart Array P420/2GB FBWC 6Gb 2-ports Int SAS Controller 631671-B21

Smart Array P421 Controller

NOTE: If a P421 controller is selected for the 12LFF model, it cannot be populated in slot 1.

HP Smart Array P421/1GB FBWC 6Gb 2-ports Ext SAS Controller 631673-B21

HP Smart Array P421/2GB FBWC 6Gb 2-ports Ext SAS Controller 631674-B21

Smart Array P430 Controller

NOTE: If a P430 controller is selected for any model, it cannot be populated in slots 3 or 4.

HP Smart Array P430/2GB FBWC 6Gb 1-port Int SAS Controller 698529-B21

Smart Array P431 Controller

HP Smart Array P431/2GB FBWC 6Gb 2-ports Ext SAS Controller 698531-B21

Smart Array P822 Controller

NOTE: If a P822 controller is selected for the 12LFF or 25SFF model, it cannot be populated in slot 3.

HP Smart Array P822/2GB FBWC 2-ports Int/4-ports Ext SAS Controller 615418-B21

NOTE: The P822 controller has only two internal ports like the P420 controller and cannot be used to attach both 8SFF drive cages through a single controller. Please see the QuickSpecs link below for Technical Specifications and additional information.

Optional Upgrades



Additional Options

| | |
|---|------------|
| HP 1GB P-series Smart Array Flash Backed Write Cache | 631679-B21 |
| HP 2GB P-series Smart Array Flash Backed Write Cache | 631681-B21 |
| HP 512MB P-series Smart Array Flash Backed Write Cache | 661069-B21 |
| HP DL38Xp Gen8 8 Large Form Factor (LFF) P430/830 Cable Kit | 729270-B21 |
| HP DL38Xp Gen8 12 Large Form Factor (LFF) P430/830 Cable Kit | 729272-B21 |
| HP DL38Xp Gen8 25 Small Form Factor (SFF) P430/830 Cable Kit | 729274-B21 |
| HP 6G SAS P430/830 Secondary Cable Kit | 729276-B21 |
| HP 6G SAS P430/830 Primary Cable Kit | 729278-B21 |
| HP Mini SAS/Straight to Straight Offset Bypass Cable Assembly | 697611-B21 |
| HP Mini SAS/Straight to Straight Short Bypass Cable Assembly | 697691-B21 |
| HP Mini SAS/Straight to Straight 25 SFF Bypass Cable Assembly | 726974-B21 |

HP Cable Options

| | |
|--|------------|
| HP Mini SAS Straight to Straight 37in Cable Assembly | 662897-B21 |
|--|------------|

NOTE: Please see the QuickSpecs for Technical Specifications and additional information:

http://h18000.www1.hp.com/products/quickspecs/14227_div/14227_div.html
(Smart Array P222 Controller)

http://h18000.www1.hp.com/products/quickspecs/14228_div/14228_div.html
(Smart Array P420 Controller)

http://h18000.www1.hp.com/products/quickspecs/14229_div/14229_div.html
(Smart Array P421 Controller)

http://h18000.www1.hp.com/products/quickspecs/14624_div/14624_div.html
(Smart Array P430 Controller)

http://h18000.www1.hp.com/products/quickspecs/14625_div/14625_div.html
(Smart Array P431 Controller)

http://h18000.www1.hp.com/products/quickspecs/14341_div/14341_div.html
(Smart Array P822 Controller)

Host Bus Adapter

| | |
|--------------------------|------------|
| HP H220 Host Bus Adapter | 650933-B21 |
| HP H221 Host Bus Adapter | 650931-B21 |
| HP H222 Host Bus Adapter | 650926-B21 |

NOTE: Please see the QuickSpecs for Technical Specifications and additional information:

http://h18004.www1.hp.com/products/quickspecs/14336_div/14336_div.html
(HBA 220)

http://h18004.www1.hp.com/products/quickspecs/14222_div/14222_div.html
(HBA 221)

http://h18004.www1.hp.com/products/quickspecs/14337_div/14337_div.html
(HBA 222)

SCSI HBA

| | |
|--|------------|
| HP SC11Xe Ultra320 Single Channel/ PCIe x4 SCSI Host Bus Adapter | 412911-B21 |
|--|------------|

NOTE: Please see the following QuickSpecs for additional information:

http://h18000.www1.hp.com/products/quickspecs/12566_div/12566_div.html
(SC11Xe HBA)

Additional Options

HP Power Cords

NOTE: HP ProLiant servers ships with an IEC-IEC power cord used for rack mounting with Power Distribution Units (PDUs).

| | |
|--|--------|
| HP C13 - SEV 1011 CH 250V 10Amp 1.83m Power Cord | AF565A |
| HP C13 - DK-2.5A DK 250V 10Amp 1.83m Power Cord | AF566A |
| HP C13 - CEE-VII EU 250V 10Amp 1.83m Power Cord | AF568A |
| HP C13 - BS-1363A UK/HK/SG 250V 10Amp 1.83m Power Cord | AF570A |
| HP C13 - CEI-23-50 IT/CL 250V 10Amp 1.83m Power Cord | AF571A |
| HP C13 - SABS-164 ZA 250V 10Amp 2.5m Power Cord | AF567A |
| HP C13 - Nema 6-15P US 250V 15A JP 3.6m Power Cord | A0N33A |
| HP C13 - Nema 5-15P US/CA 110V 10Amp 1.83m Power Cord | AF556A |

HP Tape Backup

NOTE: For the complete range of tape drives, autoloaders, libraries and media see: <http://www.hp.com/go/tape>. For hardware and software compatibility of HP tape backup products see: <http://www.hp.com/storage/SPOCK>

| | |
|---|--------|
| HP StoreEver LTO-6 Ultrium 6250 Tape Drive in 1U Rack-mount Kit | C0L99A |
| HP StoreEver LTO-6 Ultrium 6650 Internal Tape Drive | EH963A |
| HP StoreEver LTO-6 Ultrium 6650 External Tape Drive | EH964A |
| HP StoreEver LTO-6 Ultrium 6250 Internal Tape Drive | EH969A |
| HP StoreEver LTO-6 Ultrium 6250 External Tape Drive | EH970A |

HP Disk Backup

NOTE: For the complete range of RDX drives and media see: <http://www.hp.com/go/rdx>. For hardware and software compatibility of HP disk backup products see: <http://www.hp.com/storage/SPOCK>.

HP RDX Removable Disk Backup System

| | |
|---|--------|
| HP RDX320 USB3.0 External Disk Backup System | B7B63A |
| HP RDX500 USB3.0 Internal Disk Backup System | B7B64A |
| HP RDX500 USB3.0 External Disk Backup System | B7B66A |
| HP RDX1000 USB3.0 Internal Disk Backup System | B7B67A |
| HP RDX1000 USB3.0 External Disk Backup System | B7B69A |

HP RDX Removable Disk Backup Systems USB

| | |
|---|--------|
| HP RDX1000 USB3.0 Gen8 DL Server Module | B7B70A |
|---|--------|

NOTE: Please see the QuickSpecs for additional part numbers, Technical Specifications, and additional information:

http://h18000.www1.hp.com/products/quickspecs/13036_div/13036_div.html
(Worldwide)

Additional Options

HP Storage Options

Storage Fibre Channel HBA

NOTE: For the complete listing of Fibre Channel Host Bus Adapters for Windows 2000, Windows Server 2003 and Linux, please see:
<http://h18006.www1.hp.com/storage/saninfrastructure/hba.html>

Brocade Fibre Channel HBAs

| | |
|---|--------|
| HP 81B 8Gb 1-port PCIe Fibre Channel Host Bus Adapter | AP769B |
| HP 82B 8Gb 2-port PCIe Fibre Channel Host Bus Adapter | AP770B |

Emulex Fibre Channel HBAs

| | |
|--|--------|
| HP 81E 8Gb 1-port PCIe Fibre Channel Host Bus Adapter | AJ762B |
| HP 82E 8Gb 2-port PCIe Fibre Channel Host Bus Adapter | AJ763B |
| HP SN1000E 16Gb 1-port PCIe Fibre Channel Host Bus Adapter | QR558A |
| HP SN1000E 16Gb 2-port PCIe Fibre Channel Host Bus Adapter | QR559A |

QLogic Fibre Channel HBAs

| | |
|--|--------|
| HP 81Q 8Gb 1-port PCIe Fibre Channel Host Bus Adapter | AK344A |
| HP 82Q 8Gb 2-port PCIe Fibre Channel Host Bus Adapter | AJ764A |
| HP StoreFabric SN1000Q 16GB 1-port PCIe Fibre Channel Host Bus Adapter | QW971A |
| HP StoreFabric SN1000Q 16GB 2-port PCIe Fibre Channel Host Bus Adapter | QW972A |
| HP StoreFabric SN1100E 16Gb Single Port Fibre Channel Host Bus Adapter | C8R38A |
| HP StoreFabric SN1100E 16Gb Dual Port Fibre Channel Host Bus Adapter | C8R39A |

Converged Network Adapter

| | |
|--|--------|
| HP CN1100E Dual Port Converged Network Adapter | BK835A |
| HP CN1000Q Dual Port Converged Network Adapter | BS668A |
| HP StoreFabric CN1100R Dual Port Converged Network Adapter | QW990A |

HP Uninterruptible Power Systems

HP Rack-mountable UPS

HP R1500 G3 Uninterruptible Power Supply (UPS)

| | |
|--|--------|
| HP R1.5kVA G3 1U NA Uninterruptible Power System | AF469A |
| HP R1.5kVA G3 1U JP/TW Uninterruptible Power System | AF470A |
| HP R1.5kVA G3 1U INTL Uninterruptible Power System | AF471A |
| HP R/T3000 G2 2U L530 Low Voltage NA/JP Uninterruptible Power System | AF466A |

NOTE: Please see the QuickSpecs for additional information:
http://h18000.www1.hp.com/products/quickspecs/14059_div/14059_div.html
 (Worldwide)

HP R/T3000 G2 Uninterruptible Power System (UPS)

| | |
|---|--------|
| HP R/T3000 G2 2U L620 High Voltage NA/JP Uninterruptible Power System | AF467A |
| HP R/T3000 G2 2U Detachable Cord High Voltage INTL Uninterruptible Power System | AF468A |

NOTE: Please see the QuickSpecs for additional information:
http://h18000.www1.hp.com/products/quickspecs/14058_div/14058_div.html
 (Worldwide)

R5000 Uninterruptible Power System (UPS)

| | |
|---|--------|
| HP R5KVA 3U IEC309-32A High Voltage INTL Uninterruptible Power System | AF461A |
|---|--------|

Additional Options

HP R5KVA 3U L630 High Voltage NA/JP Uninterruptible Power System AF460A

NOTE: Please see the QuickSpecs for additional information:

http://h18000.www1.hp.com/products/quickspecs/14109_div/14109_div.html
(Worldwide)

R7000 Uninterruptible Power System (UPS)

HP R7KVA 4U 50A High Voltage NA/JP Uninterruptible Power System AF462A

HP R7KVA 4U IEC-32A High Voltage INTL Uninterruptible Power System AF463A

NOTE: Please see the QuickSpecs for additional information:

http://h18000.www1.hp.com/products/quickspecs/14110_div/14110_div.html
(Worldwide)

NOTE: For additional information on HP Uninterruptible Power Systems please go to: www.hp.com/servers/rackups.

NOTE: For additional information on sizing your server, please reference: <http://www.upssizer.com>.

NOTE: Please see the UPS and PDU cable matrix's on the HP Power Protection and Management page. Under Power Cords, click on the "HP Power Cord Matrix" link. That link will list cable descriptions, requirements, and specifications for UPS and PDU units. Please see the following link: www.hp.com/products/powercords.

HP Basic Power Distribution Units

HP 1.9kVA 120 Volt 12 Outlet NA/JP Basic Power Distribution Unit H5M54A

HP 2.8kVA 120 Volt 18 Outlet NA/JP Basic Power Distribution Unit H5M55A

HP 3.6kVA 200-240 Volt 12 Outlet WW Basic Power Distribution Unit H5M56A

HP 3.6kVA 200-240 Volt 20 Outlet WW Basic Power Distribution Unit H5M57A

HP 4.9kVA 208 Volt 20 Outlet NA/JP Basic Power Distribution Unit H5M58A

HP 4.9kVA 208 Volt 30 Outlet NA/JP Basic Power Distribution Unit H5M59A

HP 8.3kVA 208 Volt 36 Outlet NA/JP Basic Power Distribution Unit H5M60A

HP 8.6kVA 208 Volt Three Phase 18 Outlet NA/JP Basic Power Distribution Unit H5M61A

HP 8.6kVA 208 Volt Three Phase 30 Outlet NA/JP Basic Power Distribution Unit H5M62A

HP 5.7kVA 208 Volt Three Phase 27 Outlet NA/JP Dual Voltage Basic Power Distribution Unit H5M63A

HP 8.6kVA 208 Volt Three Phase 30 Outlet NA/JP Dual Voltage Basic Power Distribution Unit H5M64A

HP 11kVA 400 Volt Three Phase 42 Outlet NA Basic Power Distribution Unit H5M67A

HP 7.3kVA 230 Volt 20 Outlet INTL Basic Power Distribution Unit H5M68A

HP 7.3kVA 230 Volt 30 Outlet INTL Basic Power Distribution Unit H5M70A

HP 11kVA 230 Volt 36 Outlet INTL Basic Power Distribution Unit H5M71A

HP 11kVA 400 Volt Three Phase 30 Outlet INTL Basic Power Distribution Unit H5M72A

HP 11kVA 400 Volt Three Phase 42 Outlet INTL Basic Power Distribution Unit H5M73A

HP Hardwired 200-240 Volt 36 Outlet WW Basic Power Distribution Unit H5M75A

HP 13.2kVA 480 Volt Three Phase 15 Outlet NA Basic Power Distribution Unit H3X07A

HP 19.9kVA 480 Volt Three Phase 30 Outlet NA Basic Power Distribution Unit H3X08A

HP 277 Volt options for H3X07A and H3X08A

HP 800VA - 277V Input / 230V Output NA Rack Mount Transformer H3X09A

Additional Options

NOTE: Please see the QuickSpecs for Technical Specifications and additional information:

http://h18000.www1.hp.com/products/quickspecs/14557_div/14557_div.html
(Worldwide)

NOTE: Additional HP Power Distribution Units are available. For a complete list of all HP PDUs and additional information please visit

www.hp.com/go/rackandpower.

| | | |
|--|---|--------|
| HP Remote Monitoring Power Distribution Units | HP 2.8kVA 120 Volt 12 Outlet NA/JP Monitored Power Distribution Unit | D9N43A |
| | HP 4.9kVA 208 Volt 12 Outlet NA/JP Monitored Power Distribution Unit | D9N44A |
| | HP 3.6kVA 200-240 Volt 16 Outlet WW Monitored Power Distribution Unit | D9N45A |
| | HP 3.6kVA 200-240 Volt 12 Outlet WW Monitored Power Distribution Unit | D9N46A |
| | HP 4.9kVA 208 Volt 24 Outlet NA/JP Monitored Power Distribution Unit | D9N47A |
| | HP 7.3kVA 230 Volt 24 Outlet INTL Monitored Power Distribution Unit | D9N48A |
| | HP 8.3kVA 208 Volt 33 Outlet NA Monitored Power Distribution Unit | D9N49A |
| | HP 7.3kVA 230 Volt 36 Outlet INTL Monitored Power Distribution Unit | D9N50A |
| | HP 8.6kVA 208 Volt Three Phase 21 Outlet NA/JP Monitored Power Distribution Unit | D9N51A |
| | HP 5.7kVA 208 Volt Three Phase 21 Outlet NA/JP Dual Voltage Monitored Power Distribution Unit | D9N52A |
| | HP 8.6kVA 208 Volt Three Phase 24 Outlet NA/JP Dual Voltage Monitored Power Distribution Unit | D9N53A |
| | HP 17.3kVA 208 Volt Three Phase 27 Outlet NA/JP Monitored Power Distribution Unit | D9N54A |
| | HP 11kVA 400 Volt Three Phase 21 Outlet INTL Monitored Power Distribution Unit | D9N55A |
| | HP 22kVA 400 Volt Three Phase 33 Outlet INTL Monitored Power Distribution Unit | D9N56A |
| | HP 11kVA 400 Volt Three Phase 33 Outlet INTL Monitored Power Distribution Unit | D9N57A |
| | HP 14.4kVA 208 Volt Three Phase 24 Outlet NA Monitored Power Distribution Unit | D9N58A |
| | HP 17.3kVA 208 Volt Three Phase 24 Outlet NA/JP Monitored Power Distribution Unit | D9N59A |
| | HP 22kVA 400 Volt Three Phase 24 Outlet INTL Monitored Power Distribution Unit | D9N60A |
| | HP 16.6kVA 400 Volt Three Phase 33 Outlet NA Monitored Power Distribution Unit | D9N61A |
| | HP 16.6kVA 400 Volt Three Phase 24 Outlet NA Monitored Power Distribution Unit | D9N62A |
| HP 19.9kVA 480 Volt Three Phase 30 Outlet NA Monitored Power Distribution Unit | D9N63A | |
| HP Environmental Sensor for Remote Monitored PDUs | | |
| HP Environmental Sensor for Remote Monitored PDUs | E2D53A | |

Additional Options

NOTE: Please see the QuickSpecs for additional information:

http://h18000.www1.hp.com/products/quickspecs/14669_div/14669_div.html
(Worldwide)

HP Intelligent Power Distribution Units (iPDU)

iPDU Core Units

| | |
|---|--------|
| HP 4.9kVA 24A Single Phase NA/JP Core Intelligent Modular Power Distribution Unit | AF520A |
| HP 8.6kVA 24A Three Phase NA/JP Core Intelligent Modular Power Distribution Unit | AF522A |
| HP 7.3kVA 32A Single Phase INTL Core Intelligent Modular Power Distribution Unit | AF525A |
| HP 11kVA 16A Three Phase INTL Core Intelligent Modular Power Distribution Unit | AF526A |

iPDU Extension Bars

| | |
|---|--------|
| HP 5xC13 Intelligent PDU Extension Bar G2 Kit | AF547A |
| HP 5xC13 Outlets Power and UID LEDs Pair Standard Extension Bar | AF528A |

NOTE: Please see the QuickSpecs for Technical Specifications and additional information:

http://h18000.www1.hp.com/products/quickspecs/13650_div/13650_div.html
(Worldwide)

NOTE: Additional HP Power Distribution Units are available. For a complete list of all HP PDUs and additional information please visit www.hp.com/go/rackandpower.

HP Power Distribution Units

Monitored PDUs

HP Monitored Power Distribution Unit: Full Rack Version

| | |
|---|--------|
| HP 8.6kVA 24A Single Input Three Phase NA/JP Monitored Power Distribution Unit | AF504A |
| HP 8.3kVA 40A Single Input Single Phase NA/JP Monitored Power Distribution Unit | AF506A |
| HP 11kVA 16A Single Input Three Phase INTL Monitored Power Distribution Unit | AF508A |
| HP 7.3kVA 32A Single Input Single Phase INTL Monitored Power Distribution Unit | AF510A |

HP Monitored Power Distribution Unit: Half Rack Version

| | |
|---|--------|
| HP 4.9kVA 24A Single Input Single Phase NA/JP Monitored Power Distribution Unit | AF914A |
| HP 7.3kVA 32A Single Input Single Phase INTL Monitored Power Distribution Unit | AF915A |

NOTE: Please see the QuickSpecs for Technical Specifications and additional information:

http://h18000.www1.hp.com/products/quickspecs/12118_div/12118_div.html

NOTE: Additional HP Power Distribution Units are available. For a complete list of all HP PDUs and additional information please visit www.hp.com/go/rackandpower.

NOTE: Please see the UPS and PDU cable matrix's on the HP Power Protection and Management page. Under Power Cords, click on the "HP Power Cord Matrix" link. That link will list cable descriptions, requirements, and specifications for UPS and PDU units. Please see the following link: www.hp.com/products/powercords.

NOTE: This PDU has a detachable input power cord and allows for adaptability to country specific power requirements.

Additional Options

HP Rack Series

HP Intelligent Series Rack

| | |
|--|--------|
| HP 636 1075mm Pallet Intelligent Series Rack | BW895A |
| HP 636 1075mm Shock Intelligent Series Rack | BW896A |
| HP 642 1075mm Pallet Intelligent Series Rack | BW903A |
| HP 642 1075mm Shock Intelligent Series Rack | BW904A |
| HP 647 1075mm Pallet Intelligent Series Rack | BW911A |
| HP 647 1075mm Shock Intelligent Series Rack | BW912A |

NOTE: Please see the QuickSpecs for Technical Specifications such as height, width, depth, weight, and color:

http://h18000.www1.hp.com/products/quickspecs/14223_div/14223_div.html
(Worldwide)

NOTE: For additional information regarding HP Rack Cabinets, please see the following URL: <http://www.hp.com/go/rackandpower>.

HP Rack Options

HP Location Discovery Services

| | |
|-------------------------------|--------|
| HP 36U Location Discovery Kit | BW945A |
| HP 42U Location Discovery Kit | BW946A |
| HP 47U Location Discovery Kit | BW947A |

NOTE: Please see the QuickSpecs for Technical Specifications and additional information:

http://h18000.www1.hp.com/products/quickspecs/14429_div/14429_div.html
(Worldwide)

HP TFT7600 G2 KVM Console and Monitor (TFT7600 G2)

| | |
|---|--------|
| HP TFT7600 G2 KVM Console Rackmount Keyboard US Monitor | AZ870A |
| HP TFT7600 G2 KVM Console Rackmount Keyboard UK Monitor | AZ871A |
| HP TFT7600 G2 KVM Console Rackmount Keyboard DE Monitor | AZ872A |
| HP TFT7600 G2 KVM Console Rackmount Keyboard FR Monitor | AZ873A |
| HP TFT7600 G2 KVM Console Rackmount Keyboard IT Monitor | AZ874A |
| HP TFT7600 G2 KVM Console Rackmount Keyboard ES Monitor | AZ875A |
| HP TFT7600 G2 KVM Console Rackmount Keyboard DK Monitor | AZ876A |
| HP TFT7600 G2 KVM Console Rackmount Keyboard NO Monitor | AZ877A |
| HP TFT7600 G2 KVM Console Rackmount Keyboard SE/FI Monitor | AZ878A |
| HP TFT7600 G2 KVM Console Rackmount Keyboard CH Monitor | AZ879A |
| HP TFT7600 G2 KVM Console Rackmount Keyboard PT Monitor | AZ880A |
| HP TFT7600 G2 KVM Console Rackmount Keyboard BE Monitor | AZ881A |
| HP TFT7600 G2 KVM Console Rackmount Keyboard JP Monitor | AZ882A |
| HP TFT7600 G2 KVM Console Rackmount Keyboard RU Monitor | AZ883A |
| HP TFT7600 G2 KVM Console Rackmount Keyboard Intl Monitor | AZ884A |
| HP TFT7600 G2 KVM Console Rackmount Keyboard US TAA Monitor | AZ885A |

NOTE: Please see the QuickSpecs for Technical Specifications and additional information:

http://h18000.www1.hp.com/products/quickspecs/13731_div/13731_div.html
(Worldwide)

Additional Options

HP USB Keyboard and Mouse

| | |
|---|------------|
| HP USB BFR with PVC Free UK Keyboard/Mouse Kit | 631344-B21 |
| HP USB BFR with PVC Free FR Keyboard/Mouse Kit | 631346-B21 |
| HP USB BFR with PVC Free ES Keyboard/Mouse Kit | 631348-B21 |
| HP USB BFR with PVC Free DE Keyboard/Mouse Kit | 631358-B21 |
| HP USB BFR with PVC Free JP Keyboard/Mouse Kit | 631360-B21 |
| HP USB BFR with PVC Free IT Keyboard/Mouse Kit | 631362-B21 |
| HP USB BFR with PVC Free CN Keyboard/Mouse Kit | 631364-B21 |
| HP USB BFR with PVC Free AE Keyboard/Mouse Kit | 638212-B21 |
| HP USB BFR with PVC Free RU Keyboard/Mouse Kit | 638214-B21 |
| HP USB BFR with PVC Free AP-Intl Keyboard/Mouse Kit | 672097-373 |
| HP USB BFR with PVC Free Intl Keyboard/Mouse Kit | 672097-B33 |
| HP USB BFR with PVC Free PT Keyboard/Mouse Kit | 672097-133 |
| HP USB BFR with PVC Free TR Keyboard/Mouse Kit | 672097-143 |
| HP USB BFR with PVC Free CZ Keyboard/Mouse Kit | 672097-223 |
| HP USB BFR with PVC Free FI Keyboard/Mouse Kit | 672097-353 |
| HP USB BFR with PVC Free SE Keyboard/Mouse Kit | 672097-103 |
| HP USB BFR with PVC Free CH Keyboard/Mouse Kit | 672097-113 |
| HP USB BFR with PVC Free KR Keyboard/Mouse Kit | 672097-KD3 |
| HP USB BFR with PVC Free IN Keyboard/Mouse Kit | 672097-D63 |

NOTE: Please see the QuickSpecs for Technical Specifications and additional information:

http://h18000.www1.hp.com/products/quickspecs/13972_div/13972_div.html
(Worldwide)

HP Server Console Switches

| | |
|---|--------|
| HP Server Console 0x2x8 Port Analog Switch | AF616A |
| HP Server Console 0x2x16 Port Analog Switch | AF617A |
| HP TAA 0x2x16xKVM Server Console G2 Switch | AF626A |

NOTE: Please see the QuickSpecs for Technical Specifications and additional information:

http://h18000.www1.hp.com/products/quickspecs/11834_div/11834_div.html
(Worldwide)

HP Server Console Switch G2 with Virtual Media & CAC

| | |
|--|------------|
| HP 0x2x16 KVM Server Console Switch G2 with Virtual Media CAC Software | AF618A |
| HP 0x2x32 KVM Server Console Switch G2 with Virtual Media CAC Software | AF619A |
| HP KVM CAT5 1-pack USB Interface Adapter | 336047-B21 |

NOTE: Please see the QuickSpecs for Technical Specifications and additional information:

http://h18000.www1.hp.com/products/quickspecs/13475_div/13475_div.html
(Worldwide)

| | |
|---|--------|
| HP IP Console Switch G2 with Virtual Media & CAC | |
| HP 1x4 USB/PS2 KVM Console Switch | AF611A |
| HP 1x1Ex8 KVM IP Console Switch G2 with Virtual Media CAC Software | AF620A |
| HP 2x1Ex16 KVM IP Console Switch G2 with Virtual Media CAC Software | AF621A |
| HP 4x1Ex32 KVM IP Console Switch G2 with Virtual Media CAC Software | AF622A |

Additional Options

NOTE: Please see the QuickSpecs for Technical Specifications and additional information:

http://h18000.www1.hp.com/products/quickspecs/13474_div/13474_div.html
(Worldwide)

Rail Kits

NOTE: Gen8 rail kits have changed significantly from prior generation rail kits. Please take a moment to review the installation documentation that comes with the server to help you with the installation of your Gen8 server.

NOTE: Rail kits are optional for DL380p Gen8 and are no longer included standard with the server. Customers have the option to purchase their server without a rail kit.

NOTE: Ball bearing rail kits contain telescoping rails which allow for in-rack serviceability.

NOTE: The HP 2U Gen8 Cable Management Arm is not available when using Friction Rails.

NOTE: To assist in the installation of the server into the rack an optional installation tool is available by contacting your local services representative (p/n 695539-001).

Caution: HP recommends that a minimum of two people are required for all Rack Server installations. Please refer to your installation instructions for proper tools and number of people to use for any installation.

| | |
|---|------------|
| HP 2U Large Form Factor Ball Bearing Gen8 Rail Kit with CMA | 663480-B21 |
| HP 2U Small Form Factor Ball Bearing Gen8 Rail Kit with CMA | 663478-B21 |
| HP 2U Small Form Factor Ball Bearing Gen8 Rail Kit | 720863-B21 |
| HP 2U Large Form Factor Ball Bearing Gen8 Rail Kit | 720864-B21 |
| HP 2U Cable Management Arm for Ball Bearing Gen8 Rail Kit | 720865-B21 |

HP USB and SD options

HP Flash Media Kits for USB Drives

HP 2GB USB Flash Media Drive Key Kit 608447-B21

NOTE: HP qualified blank USB key for use with HP ProLiant servers that support the VMware virtualization environment and other HP value-add software. HP recommends this industry standard USB flash device for use with VMware ESXi. USB device must be installed in the internal slot of the ProLiant server for use with VMware ESXi. Refer to HP VMware Getting Started Guide for installation instructions.

HP Enterprise Performance Flash Media Kits for Memory Cards

HP 4GB SD Enterprise Performance Flash Media Kit 580387-B21

NOTE: Blank SD media device is supported for use with VMware and Citrix. SD media must be installed in the internal slot of the ProLiant server. Learn more at: <http://www.hp.com/go/proliantvirtualization>.

HP 32GB SD Enterprise Mainstream Flash Media Kit

HP 8GB SD Enterprise Mainstream Flash Media Kit 726113-B21

HP 32GB SD Enterprise Mainstream Flash Media Kit 700136-B21

Other USB and SD Options

HP USB 04 Standard Keyboard DT528A#ABA

Additional Options

HP Care Pack Services Proactive Care

NOTE: Collaborative Support plus Proactive services delivered by the onshore, local language Advanced Solution Center (ASC), end-to-end case ownership from a Technical Solution Specialists and Technical Account Manager who remotely delivers firmware/software revision management, proactive scans and incident trend reports. Recommended for customers running a virtualized infrastructure and/or customers who desire an enhanced call support experience.

| | |
|--|--------|
| HP 3 year 4 hour 24x7 ProLiant DL38x(p) Proactive Care Service | U2Z50E |
| HP 3 year 4 hour 24x7 with Defective Media Retention ProLiant DL38x(p) Proactive Care Service | U2Z53E |
| HP 3 year 6 hour Call To Repair 24x7 ProLiant DL38x(p) Proactive Care Service | U2Z56E |
| HP 3 year 6 hour Call To Repair 24x7 w/DefectiveMedia Retention ProLiant DL38x(p) Proactive Care SVC | U2Z59E |
| HP 3 year 4 hour 24x7 ProLiant DL38x(p) with Insight Control Proactive Care Service | U3N23E |
| HP 3 year 4hr 24x7 with Defective Media Retention DL38x(p) with Insight Control Proactive Care SVC | U3N26E |
| HP 3 year 6 hour Call To Repair 24x7 ProLiant DL38x(p) with Insight Control Proactive Care Service | U3N29E |
| HP 3yr 6hrCallToRepair 24x7w/Defective Media Retention DL38x(p) w/Insight Control Proactive Care SVC | U3N32E |

NOTE: For more information, customer/resellers can contact:
<http://www.hp.com/services/carepack>

Memory

For detailed memory configuration rules and guidelines, please use the Online DDR3 Memory Configuration Tool: www.hp.com/go/ddr3memory-configurator

Memory Subsystem Architecture

Each Intel® Xeon® E5-2600 family processor socket contains four memory channels that support three DIMMs each for a total of twelve (12) DIMM per installed processor or a grand total of twenty-four (24) DIMMs for the server. Up to 32GB capacity DIMMs are supported for 768GB of memory (24 DIMM slots x 32GB per DIMM).

Memory population guidelines

DIMM configuration

NOTE: This information is only for Advanced EEC memory mode. See the user guide for other memory modes.

Key: Alpha - population order
 Numeric - DIMM slot ID for spare replacement

- Before installing DIMMs, review the population rules:
 - Do not install DIMMs if the corresponding processor is not installed.
 - When two processors are installed, balance the DIMMs across the two processors
 - DIMM slots that are white denote the first slot of a channel (Ch 1-A, Ch 2-B, Ch 3-C, Ch 4-D...).
 - Do not mix UDIMMs, RDIMMs, or LRDIMMs.
 - Do not install more than two UDIMMs per channel. UDIMMs should be installed in slots Ch 1-I, Ch 2-J, Ch 3-K, Ch 4-L.
- When two processors are installed, install DIMMs in dequential alphabetical order balanced between the two processors: P1-A, P2-A, P1-B, P2-B, P1-C, P2-C...
- For DIMM spare replacement, install the DIMMs per slot number as instructed by your system software.

For additional DIMM information, see the user guide at: hp.com > support & drivers > product support & troubleshooting > enter your product

General Memory Population Rules and Guidelines:

- White DIMM slots denote the first slot of a channel. For 1 DPC (DIMM per channel) populate white slots only.
- Install DIMMs only if the corresponding processor is installed.
- If only one processor is installed in a two processor system, only half of the DIMM slots are available.
- To maximize performance, it is recommended to balance the total memory capacity between all installed processors and to load the channels similarly whenever possible.
- Populate DIMMs from heaviest load (quad-rank) to lightest load (single-rank) within a channel. Heaviest load (DIMM with most ranks) within a channel goes furthest from the processor
- RDIMMs operating at either 1.35V or 1.5V may be mixed in any order, but the system will power them at the higher voltage.
- Do not mix RDIMMs, LRDIMMs, and UDIMMs.
- LRDIMMs are supported up to 3 DIMMs per channel.
- Using the HP RBSU, 1.35V DIMMs can be changed to operate at 1.5V.
- DIMMs of different speeds may be mixed in any order; the server will select a common optimal speed.
- The maximum memory speed is a function of the memory type, memory configuration, and processor model.
- The maximum memory capacity is a function of the memory type and number of installed processors.
- HP memory from previous generation servers is not qualified on the DL380p Gen8 Server. Certain HP SmartMemory features such as memory authentication and enhanced performance may not be supported.
- To realize the performance memory capabilities listed in this document, HP SmartMemory is required. For additional information, please see the HP SmartMemory QuickSpecs at: http://h18000.www1.hp.com/products/quickspecs/14225_div/14225_div.html.
- For memory population rules and additional memory guidelines, please see the DL380p Gen8 user guide at <http://www.hp.com/support>.

| Supported Memory Bandwidth for DL380p Gen8 with Intel® Xeon® E5-2600 v2 Series Processor Family | | | |
|---|---------------|------------------------|-----------------|
| DIMM Type -> | Register DIMM | Load Reduced (LRDIMMs) | Unbuffered DIMM |
| | | | |

Memory

| DIMM Rank -> | Single Rank (1R) | | Dual Rank (2R) | | Single Rank (1R) | | Dual Rank (2R) | | Quad Rank (4R) | Single Rank (1R) | | Dual Rank (2R) | | | |
|-----------------------------|------------------|------|----------------|------|------------------|------|----------------|------|----------------|------------------|------|----------------|------|------|------|
| | 4GB | 8GB | 8GB | 8GB | 8GB | 8GB | 16GB | 16GB | | 2GB | 4GB | 4GB | 8GB | 8GB | |
| DIMM Capacity -> | 4GB | 8GB | 8GB | 8GB | 8GB | 8GB | 16GB | 16GB | 32GB | 2GB | 4GB | 4GB | 8GB | 8GB | |
| DIMM Native Speed (MT/s) -> | 1600 | 1866 | 1600 | 1866 | 1600 | 1866 | 1600 | 1866 | 1866 | 1600 | 1866 | 1600 | 1866 | 1600 | 1866 |
| Voltage | LV | Std | LV | Std | LV | Std | LV | Std | Std | LV | Std | LV | Std | LV | Std |

SLOTS THAT CAN BE POPULATED

| | | | | | | | | | | | | | | | |
|------------------|----|----|----|----|----|----|----|----|----|-----|-----|-----|-----|-----|-----|
| 12 slot servers | 12 | 12 | 12 | 12 | 12 | 12 | 12 | 12 | 12 | 12 | 12 | 12 | 12 | 12 | 12 |
| 16 slot servers | 16 | 16 | 16 | 16 | 16 | 16 | 16 | 16 | 16 | 16 | 16 | 16 | 16 | 16 | 16 |
| 24 slot servers | 24 | 24 | 24 | 24 | 24 | 24 | 24 | 24 | 24 | 16 | 16 | 16 | 16 | 16 | 16 |
| 32 slot server | 32 | 32 | 32 | 32 | 32 | 32 | 32 | 32 | 32 | n/a | n/a | n/a | n/a | n/a | n/a |
| 48 slot servers | 48 | 48 | 48 | 48 | 48 | 48 | 48 | 48 | 48 | n/a | n/a | n/a | n/a | n/a | n/a |
| 64 slot servers# | 64 | 64 | 64 | 64 | 64 | 64 | 64 | 64 | 64 | n/a | n/a | n/a | n/a | n/a | n/a |

MAXIMUM CAPACITY (GB)*

| | | | | | | | | | | | | | | | |
|------------------|-----|-----|-----|-----|-----|-----|------|------|------|-----|-----|-----|-----|-----|-----|
| 12 slot servers | 48 | 48 | 96 | 96 | 96 | 96 | 192 | 192 | 384 | 24 | 24 | 48 | 48 | 96 | 96 |
| 16 slot servers | 64 | 64 | 128 | 128 | 128 | 128 | 256 | 256 | 512 | 32 | 32 | 64 | 64 | 128 | 128 |
| 24 slot servers | 96 | 96 | 192 | 192 | 192 | 192 | 384 | 384 | 768 | 32 | 32 | 64 | 64 | 128 | 128 |
| 32 slot servers | 128 | 128 | 256 | 256 | 256 | 256 | 512 | 512 | 1024 | n/a | n/a | n/a | n/a | n/a | n/a |
| 48 slot server | 192 | 192 | 384 | 384 | 384 | 384 | 768 | 768 | 1536 | n/a | n/a | n/a | n/a | n/a | n/a |
| 64 slot servers# | 256 | 256 | 512 | 512 | 512 | 512 | 1024 | 1024 | 2048 | n/a | n/a | n/a | n/a | n/a | n/a |

POPULATED DIMM SPEED (MT/s)

| | | | | | | | | | | | | | | | |
|----------------|------|------|------|------|------|------|------|------|------|------|------|------|------|------|------|
| 1 DIMM/Channel | 1600 | 1866 | 1600 | 1866 | 1600 | 1866 | 1600 | 1866 | 1866 | 1600 | 1866 | 1600 | 1866 | 1600 | 1866 |
| 2 DIMM/Channel | 1600 | 1866 | 1600 | 1866 | 1600 | 1866 | 1600 | 1866 | 1866 | 1600 | 1866 | 1600 | 1866 | 1600 | 1866 |
| 3 DIMM/Channel | 800 | 1066 | 800 | 1066 | 800 | 1066 | 800 | 1066 | 1333 | n/a | n/a | n/a | n/a | n/a | n/a |

Memory

Memory speed is a function of the processor QPI bus speed.

* Maximum capacity will vary based on individual server platform qualification schedule

For HP SmartMemory, UDIMM is supported at 2DPC@DDR3-1866. Third party memory may only support up to 2DPC@DDR3-1333 or 1600.

All configurations on 64 slot server run at DDR3-1066.

Memory Speed by E5-2600 v2 Processor Model

| Processor Models | Supported Memory Speeds |
|--|-------------------------|
| E5-2697 v2, E5-2695 v2, E5-2690 v2, E5-2680 v2, E5-2670 v2, E5-2667 v2, E5-2660 v2, E5-2650 v2, E5-2643 v2, E5-2637 v2 | 1866/1600MHz |
| E5-2640 v2, E5-2630 v2, E5-2620 v2, E5-2650L v2, E5-2630L v2 | 1600MHz |
| E5-2609 v2, E5-2603 v2 | 1333MHz |

Supported Memory Bandwidth for DL380p Gen8 with Intel® Xeon® E5-2600 Series Processor Family

| DIMM Type | Registered DIMMS (RDIMMs) | | | | | | | | Load Reduced (LRDIMMs) | Unbuffered with ECC DIMMs (UDIMMs) | | | | | | "HyperClo Memory (HDIMMs) |
|-------------------------|---------------------------|------|------|----------------|------|------|------|------|------------------------|------------------------------------|------------------|------|----------------|------|------|---------------------------|
| | Single Rank (1R) | | | Dual Rank (2R) | | | | | | Quad Rank (4R) | Single Rank (1R) | | Dual Rank (2R) | | | |
| DIMM Rank | 4GB | 4GB | 8GB | 8GB | 8GB | 16GB | 16GB | 32GB | 2GB | 2GB | 4GB | 4GB | 8GB | 8GB | 16GB | |
| DIMM Capacity | 4GB | 4GB | 8GB | 8GB | 8GB | 16GB | 16GB | 32GB | 2GB | 2GB | 4GB | 4GB | 8GB | 8GB | 16GB | |
| DIMM Native Speed (MHz) | 1333 | 1600 | 1600 | 1333 | 1600 | 1333 | 1600 | 1333 | 1333 | 1600 | 1333 | 1600 | 1333 | 1600 | 1333 | |
| Voltage | LV | Std | Std | LV | Std | LV | Std | LV | LV | Std | LV | Std | LV | Std | Std | |

SLOTS THAT CAN BE POPULATED

| | | | | | | | | | | | | | | | |
|-----------------|----|----|----|----|----|----|----|----|----|----|----|----|----|----|----|
| 24 slot servers | 24 | 24 | 24 | 24 | 24 | 24 | 24 | 24 | 16 | 16 | 16 | 16 | 16 | 16 | 24 |
|-----------------|----|----|----|----|----|----|----|----|----|----|----|----|----|----|----|

MAXIMUM CAPACITY (GB)*

| | | | | | | | | | | | | | | | |
|--|----|----|-----|-----|-----|-----|-----|-----|----|----|----|----|-----|-----|-----|
| | 96 | 96 | 192 | 192 | 192 | 384 | 384 | 768 | 32 | 32 | 64 | 64 | 128 | 128 | 384 |
|--|----|----|-----|-----|-----|-----|-----|-----|----|----|----|----|-----|-----|-----|

POPULATED DIMM SPEED (MHz)

| | | | | | | | | | | | | | | | |
|--------------------|--------|---------|---------|--------|---------|--------|---------|---------|----------|------|----------|------|----------|------|---------|
| 1 DIMM Per Channel | 1333 | 1600 | 1600 | 1333 | 1600 | 1333 | 1600 | 1333*** | 1333 | 1600 | 1333 | 1600 | 1333 | 1600 | n/a |
| 2 DIMM Per Channel | 1333 | 1600 | 1600 | 1333 | 1600 | 1333 | 1600 | 1333*** | 1333**** | 1600 | 1333**** | 1600 | 1333**** | 1600 | n/a |
| 3 DIMM Per Channel | 1066** | 1333### | 1333### | 1066** | 1333### | 1066** | 1333### | 1066 | n/a | n/a | n/a | n/a | n/a | n/a | 1333### |

NOTE: Memory speed is a function of the processor QPI bus speed. To realize the performance memory capabilities listed above HP SmartMemory is required.

* Maximum capacity will vary based on individual server platform qualification schedule

** For HP SmartMemory RDIMM supports up to 3DPC@1066 at 1.35V. Third party memory may only support up to 3DPC@1066 at 1.5V.

*** LRDIMMs enable 3 DIMMs per channel. HP SmartMemory will support up to 3DPC@1066 at 1.35V. Third party memory may support 3DPC @1066 at 1.5V.

**** For HP SmartMemory, UDIMM is supported at 2DPC@1333 at 1.35V. Third party memory may only support up to 2DPC@1066 at 1.5V.

Memory

RBSU setting required

Memory Speed by E5-2600 Processor Model

| Processor Models | Supported Memory Speeds |
|--|-------------------------|
| E5-2690 E5-2680, E5-2670, E5-2667, E5-2665, E5-2660, E5-2650, E5-2650L, E5-2643, E5-2637 | 1600/1333/1066MHz |
| E5-2640, E5-2630, E5-2630L, E5-2620 | 1333/1066MHz |
| E5-2609, E5-2603 | 1066MHz |

DIMM slot and configuration diagram

Population order; start with "A" first, "B" second, "C" third, etc.

When one processor is installed, install DIMMs in sequential alphabetic order: A, B, C, D, E, F ...

When two processors are installed, install DIMMs in sequential alphabetic order: CPU1-A, CPU2-A,CPU1-B,CPU2-B,CPU1-C, CP2-C

| 24 DIMM SLOTS (12 per CPU node) | | | | | |
|---------------------------------|--------|------------------|-------------|------------------|--------|
| | slot # | population order | slot # | population order | |
| Chnl 3 | 1 | C | 1 | C | Chnl 3 |
| | 2 | G | 2 | G | |
| | 3 | K | 3 | K | |
| Chnl 4 | 4 | D | 4 | D | Chnl 4 |
| | 5 | H | 5 | H | |
| | 6 | L | 6 | L | |
| CPU1 | | | CPU2 | | |
| Chnl 2 | 7 | J | 7 | J | Chnl 2 |
| | 8 | F | 8 | F | |
| | 9 | B | 9 | B | |
| Chnl 1 | 10 | I | 10 | I | Chnl 1 |
| | 11 | E | 11 | E | |
| | 12 | A | 12 | A | |

NOTE: Capacity references are rounded to the common Gigabyte values.

- 1GB = 1024MB
- 2GB = 2048MB
- 4GB = 4096MB
- 8GB = 8192MB
- 16GB = 16384MB
- 32GB = 32768MB

DDR3 memory options part number decoder

Memory

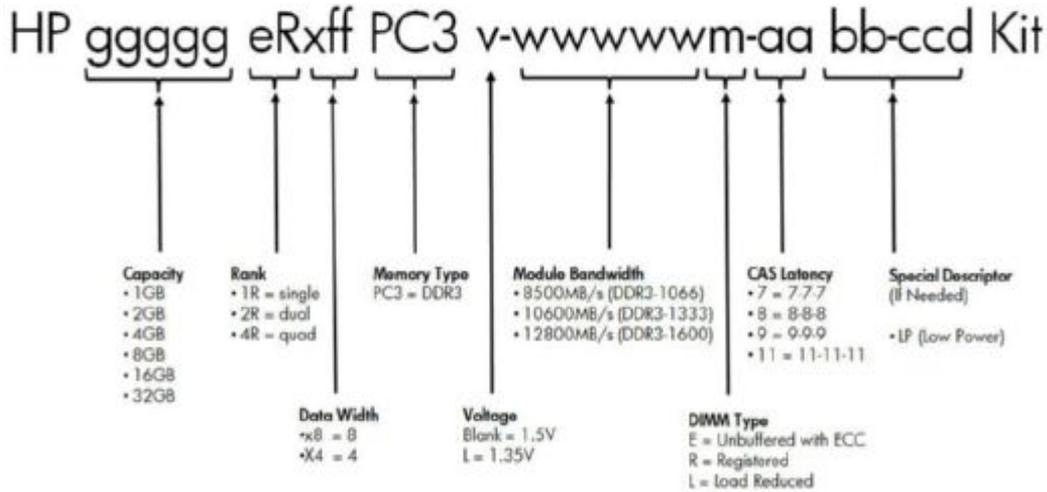

Following are memory options available from HP:

HP Memory

NOTE: HP memory from previous generation servers are not qualified or warranted with this HP ProLiant Server. HP SmartMemory is required to realize the memory performance improvements and enhanced functionality listed in this document for Gen8. For additional information, please see the HP SmartMemory QuickSpecs at:

http://h18000.www1.hp.com/products/quickspecs/14225_div/14225_div.html

NOTE: LRDIMM, RDIMM and UDIMMs are all distinct memory technologies and cannot be mixed within a server. The majority of ProLiant Gen8 servers support RDIMM, UDIMM and LRDIMM.

Registered DIMMs (RDIMMs)

NOTE: The following memory is supported by the E5-2600 v2 series Processors.

| | |
|--|------------|
| HP 4GB (1x4GB) Single Rank x4 PC3L-12800R (DDR3-1600) Registered CAS-11 Low Voltage Memory Kit | 713981-B21 |
| HP 4GB (1x4GB) Single Rank x4 PC3-14900R (DDR3-1866) Registered CAS-13 Memory Kit | 708637-B21 |
| HP 8GB (1x8GB) Dual Rank x4 PC3L-12800R (DDR3-1600) Registered CAS-11 Low Voltage Memory Kit | 713983-B21 |
| HP 8GB (1x8GB) Single Rank x4 PC3L-12800R (DDR3-1600) Registered CAS-11 Low Voltage Memory Kit | 731765-B21 |
| HP 8GB (1x8GB) Dual Rank x4 PC3-14900R (DDR3-1866) Registered CAS-13 Memory Kit | 708639-B21 |
| HP 8GB (1x8GB) Single Rank x4 PC3-14900R (DDR3-1866) Registered CAS-13 Memory Kit | 731761-B21 |
| HP 16GB (1x16GB) Dual Rank x4 PC3L-12800R (DDR3-1600) Registered CAS-11 Low Voltage Memory Kit | 713985-B21 |
| HP 16GB (1x16GB) Dual Rank x4 PC3-14900R (DDR3-1866) Registered CAS-13 Memory Kit | 708641-B21 |

Registered DIMMs (RDIMMs)

NOTE: The following memory is supported by the E5-2600 series Processors.

| | |
|---|------------|
| HP 4GB (1x4GB) Single Rank x4 PC3L-10600R (DDR3-1333) Registered CAS-9 Low Voltage Memory Kit | 647893-B21 |
|---|------------|

Memory

| | |
|---|------------|
| HP 4GB (1x4GB) Single Rank x4 PC3-12800R (DDR3-1600) Registered CAS-11 Memory Kit | 647895-B21 |
| HP 8GB (1x8GB) Dual Rank x4 PC3L-10600R (DDR3-1333) Registered CAS-9 Low Voltage Memory Kit | 647897-B21 |
| HP 8GB (1x8GB) Single Rank x4 PC3-12800R (DDR3-1600) Registered CAS-11 Memory Kit | 647899-B21 |
| HP 8GB (1x8GB) Dual Rank x4 PC3-12800R (DDR3-1600) Registered CAS-11 Memory Kit | 690802-B21 |
| HP 16GB (1x16GB) Dual Rank x4 PC3L-10600R (DDR3-1333) Registered CAS-9 Low Voltage Memory Kit | 647901-B21 |
| HP 16GB (1x16GB) Dual Rank x4 PC3-12800R (DDR3-1600) Registered CAS-11 Memory Kit | 672631-B21 |
| Unbuffered with ECC DIMMs (UDIMMs) | |
| NOTE: The following memory is supported by the E5-2600 v2 series Processors. | |
| HP 2GB (1x2GB) Single Rank x8 PC3L-12800E (DDR3-1600) Unbuffered CAS-11 Low Voltage Memory Kit | 713975-B21 |
| HP 2GB (1x2GB) Single Rank x8 PC3-14900E (DDR3-1866) Unbuffered CAS-13 Memory Kit | 708631-B21 |
| HP 4GB (1x4GB) Dual Rank x8 PC3L-12800E (DDR3-1600) Unbuffered CAS-11 Low Voltage Memory Kit | 713977-B21 |
| HP 4GB (1x4GB) Dual Rank x8 PC3-14900E (DDR3-1866) Unbuffered CAS-13 Memory Kit | 708633-B21 |
| HP 8GB (1x8GB) Dual Rank x8 PC3L-12800E (DDR3-1600) Unbuffered CAS-11 Low Voltage Memory Kit | 713979-B21 |
| HP 8GB (1x8GB) Dual Rank x8 PC3-14900E (DDR3-1866) Unbuffered CAS-13 Memory Kit | 708635-B21 |
| Unbuffered with ECC DIMMs (UDIMMs) | |
| NOTE: The following memory is supported by the E5-2600 series Processors. | |
| HP 2GB (1x2GB) Single Rank x8 PC3-12800E (DDR3-1600) Unbuffered CAS-11 Memory Kit | 669320-B21 |
| HP 2GB (1x2GB) Single Rank x8 PC3L-10600E (DDR3-1333) Unbuffered CAS-9 Low Voltage Memory Kit | 647905-B21 |
| HP 4GB (1x4GB) Dual Rank x8 PC3-12800E (DDR3-1600) Unbuffered CAS-11 Memory Kit | 669322-B21 |
| HP 4GB (1x4GB) Dual Rank x8 PC3L-10600E (DDR3-1333) Unbuffered CAS-9 Low Voltage Memory Kit | 647907-B21 |
| HP 8GB (1x8GB) Dual Rank x8 PC3-12800E (DDR3-1600) Unbuffered CAS-11 Memory Kit | 669324-B21 |
| HP 8GB (1x8GB) Dual Rank x8 PC3L-10600E (DDR3-1333) Unbuffered CAS-9 Low Voltage Memory Kit | 647909-B21 |
| Load Reduced DIMMs (LRDIMMs) | |
| NOTE: The following memory is supported by the E5-2600 v2 series Processors. | |
| HP 32GB (1x32GB) Quad Rank x4 PC3-14900L (DDR3-1866) Load Reduced CAS-13 Memory Kit | 708643-B21 |
| Load Reduced DIMMs (LRDIMMs) | |
| NOTE: The following memory is supported by the E5-2600 series Processors. | |
| HP 32GB (1x32GB) Quad Rank x4 PC3L-10600L (DDR3-1333) Load Reduced CAS-9 Low Voltage Memory Kit | 647903-B21 |

Memory

HyperCloud DIMMs (HDIMMs)

NOTE: The following memory is supported by the E5-2600 series Processors.

HP 32GB (1x32GB) Dual Rank x4 PC3-10600H (DDR3-1333) HyperCloud CAS-9 Memory Kit 715166-B21

NOTE: All DDR3 memory option kits consist of one DIMM per kit. For detailed memory configuration rules and guidelines, please use the Online DDR3 Memory Configuration Tool: www.hp.com/go/ddr3memory-configurator.

NOTE: For more information on ProLiant Energy Efficient Features, see: www.hp.com/go/proliant-energy-efficient

NOTE: PC3L is a low voltage memory.

Storage

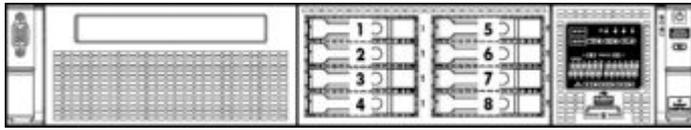

1-8 Eight SFF SAS hot plug drive bays

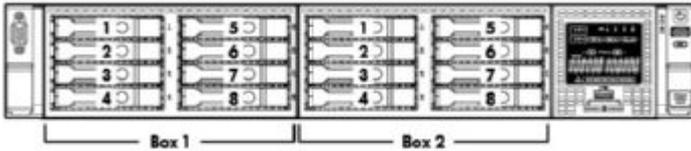

1-16 Sixteen SFF SAS hot plug drive bays
NOTE: This configuration does not support optical drive.
NOTE: This configuration requires the addition of a second controller for the second drive cage.

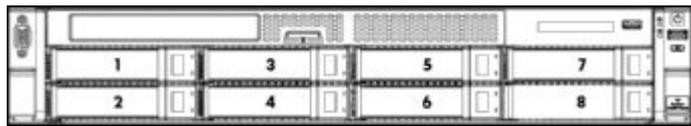

1-8 Eight LFF SAS hot plug drive bays.

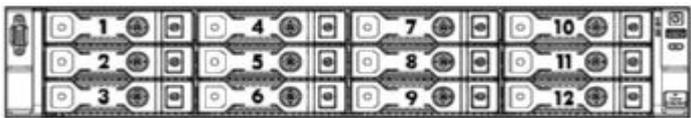

1-12 Twelve LFF SAS hot plug drive bays.
NOTE: This configuration does not support optical drive.
NOTE: This configuration has a built-in expander that is driven by the embedded controller.

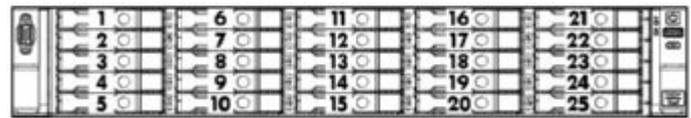

1-25 Twenty-five SFF SAS hot plug drive bays.
NOTE: This configuration does not support optical drive.
NOTE: This configuration has a built-in expander that is driven by the embedded controller.

Maximum Storage Capacity - (with D2700, SAS/SATA HDD)

| | |
|----------|------------------------------------|
| Internal | 30TB (25 SFF HDDs x 1.2TB SAS SFF) |
| Internal | 48TB (12 LFF HDDs x 4TB SATA LFF) |
| External | 240TB (200 x 1.2TB SAS SFF) |
| Total | 270TB (D2700 + DL380p Gen8 25 SFF) |
| | 288TB (D2700 + DL380p Gen8 12 LFF) |

Technical Specifications

| | | | | | | | | | |
|---|---|--|---------|---|--|--|---------|--------------------|---|
| System Unit | Dimensions (H x W x D) (with bezel) | SFF Drives: 3.44 x 17.54 x 27.50 in (8.73 x 44.55 x 69.85 cm) LFF Drives: 3.44 x 17.54 x 29.50 in (8.73 x 44.55 x 74.93 cm) | | | | | | | |
| | Weight (approximate) | <table border="0"> <tr> <td>Maximum</td> <td>61.00 lb (27.66 kg)</td> </tr> <tr> <td colspan="2">(all LFF hard drives, power supply, and processor installed)</td> </tr> <tr> <td>Minimum</td> <td>41.0 lb (18.59 kg)</td> </tr> <tr> <td colspan="2">(one SFF hard drive, power supply, and processor installed, ODD not installed)</td> </tr> </table> | Maximum | 61.00 lb (27.66 kg) | (all LFF hard drives, power supply, and processor installed) | | Minimum | 41.0 lb (18.59 kg) | (one SFF hard drive, power supply, and processor installed, ODD not installed) |
| Maximum | 61.00 lb (27.66 kg) | | | | | | | | |
| (all LFF hard drives, power supply, and processor installed) | | | | | | | | | |
| Minimum | 41.0 lb (18.59 kg) | | | | | | | | |
| (one SFF hard drive, power supply, and processor installed, ODD not installed) | | | | | | | | | |
| Input Requirements (per power supply) | Rated Line Voltage | 100 to 120 VAC 200 to 240 VAC | | | | | | | |
| | Rated Input Current | For 1200 W Power Supply: 10 A (at 100 VAC), 4.9 A (at 200 VAC) For 750 W Power Supply: 8.9 A (at 100 VAC), 4.3 A (at 200 VAC) For 460 W Power Supply: 5.5 A (at 100 VAC), 2.6 A (at 200 VAC) | | | | | | | |
| | Rated Input Frequency | 50 to 60 Hz | | | | | | | |
| | Rated Input Power | For 1200 W Power Supply: 930 W (at 100 VAC), 1348 W (at 200 VAC) For 750 W Power Supply: 857 W (at 100 VAC), 824 W (at 200 VAC) For 460 W Power Supply: 526 W (at 100 VAC), 505 W (at 200 VAC) | | | | | | | |
| | BTU Rating | <table border="0"> <tr> <td>Maximum</td> <td> For 1200 W Power Supply: 3530 BTU/hr (at 100 VAC), 4600 BTU/hr (at 200 VAC) For 750 W Power Supply: 2925 BTU/hr (at 100 VAC), 2812 BTU/hr (at 200 VAC) For 460 W Power Supply: 1794 BTU/hr (at 100 VAC), 1725 BTU/hr (at 200 VAC) </td> </tr> </table> | Maximum | For 1200 W Power Supply: 3530 BTU/hr (at 100 VAC), 4600 BTU/hr (at 200 VAC) For 750 W Power Supply: 2925 BTU/hr (at 100 VAC), 2812 BTU/hr (at 200 VAC) For 460 W Power Supply: 1794 BTU/hr (at 100 VAC), 1725 BTU/hr (at 200 VAC) | | | | | |
| Maximum | For 1200 W Power Supply: 3530 BTU/hr (at 100 VAC), 4600 BTU/hr (at 200 VAC) For 750 W Power Supply: 2925 BTU/hr (at 100 VAC), 2812 BTU/hr (at 200 VAC) For 460 W Power Supply: 1794 BTU/hr (at 100 VAC), 1725 BTU/hr (at 200 VAC) | | | | | | | | |
| Power Supply Output (per power supply) | Rated Steady-State Power | For 1200 W Power Supply: 800 W (at 100 VAC), 900 W (at 120 VAC), 1200 W (at 200 to 240 VAC) For 750 W Power Supply: 750 W (at 100 to 120 VAC), 750 W (at 200 to 240 VAC) For 460 W Power Supply: 460 W (at 100 to 120 VAC), 460 W (at 200 to 240 VAC) | | | | | | | |

Technical Specifications

| | | |
|---|--|---|
| | Maximum Peak Power | For 1200 W Power Supply: 800 W (at 100 VAC), 900 W (at 120 VAC), 1200 W (at 200 to 240 VAC) For 750 W Power Supply: 750 W (at 100 to 120 VAC), 750 W (at 200 to 240 VAC) For 460 W Power Supply: 460 W (at 100 to 120 VAC), 460 W (at 200 to 240 VAC) |
| System Inlet Temperature | Operating | 10° to 35°C (50° to 95°F) at sea level with an altitude derating of 1.0°C per every 304.8 m (1.8°F per every 1000 ft) above sea level to a maximum of 3048 m (10,000 ft), no direct sustained sunlight. Maximum rate of change is 10°C/hr (18°F/hr). The upper limit may be limited by the type and number of options installed. System performance may be reduced if operating with a fan fault or above 30°C (86°F). |
| | Non-operating | -30° to 60°C (-22° to 140°F). Maximum rate of change is 20°C/hr (36°F/hr). |
| Relative Humidity (non-condensing) | Operating | 10% to 90% relative humidity (Rh), 28°C (82.4°F) maximum wet bulb temperature, non-condensing. |
| | Non-operating | 5% to 95% relative humidity (Rh), 38.7°C (101.7°F) maximum wet bulb temperature, non-condensing. |
| Altitude | Operating | 3048 m (10,000 ft). This value may be limited by the type and number of options installed. Maximum allowable altitude change rate is 457 m/min (1500 ft/min). |
| | Non-operating | 9144 m (30,000 ft). Maximum allowable altitude change rate is 457 m/min (1500 ft/min). |
| Acoustic Noise | Listed are the declared A-Weighted sound power levels (LWAd) and declared average bystander position A-Weighted sound pressure levels (LpAm) when the product is operating in a 23°C ambient environment. Noise emissions were measured in accordance with ISO 7779 (ECMA 74) and declared in accordance with ISO 9296 (ECMA 109). The listed sound levels apply to standard shipping configurations. Additional options may result in increased sound levels. NOTE: The Listed sound levels apply to standard shipping configurations. Additional options may result in increased sound levels. | |

| | Entry | Base | Performance |
|------------------|--------------|-------------|--------------------|
| Idle | | | |
| LWAd | 4.1 B | 4.1 B | 4.1 B |
| LpAm | 25 dBA | 25 dBA | 25 dBA |
| Operating | | | |

Technical Specifications

| | | | | |
|---------------------------------------|---------------------|---|--------|--------|
| | LWAd | 4.3 B | 4.7 B | 5.0 B |
| | LpAm | 27 dBA | 31 dBA | 35 dBA |
| Emissions Classification (EMC) | FCC Rating | Class A | | |
| | Normative Standards | CISPR 22; EN55022; EN55024; FCC CFR 47, Pt 15; ICES-003; CNS13438; GB9254; K22;K24; EN 61000-3-2; EN 61000-3-3; EN 60950-1; IEC 60950-1 | | |

NOTE: Product conformance to cited product specifications is based on sample (type) testing, evaluation, or assessment. This product or family of products is eligible to bear the appropriate compliance logos and statements.

NOTE: The Listed sound levels apply to standard shipping configurations. Additional options may result in increased sound levels.

| | | |
|--|---|---|
| HP Smart Array P420i Controller | Dimensions | Embedded |
| | Disk Drive and Enclosure Interface - Transfer Rate | 6Gb/s SAS (Serial Attached SCSI) |
| | SAS Connectors | 6Gb/s SATA (Serial ATA) |
| | Cache Memory Speed | 2 internal 4X connectors |
| | Server Interface | 512MB FBWC - DDR3-1333MHz with 40-bit wide bus, 1GB or 2GB FBWC DDR3-1333MHz with 72-bit wide bus |
| | SAS Speed | x8 PCIe 3.0 provides 8GB/s maximum bandwidth |
| | Cache Memory | (8) 6Gb/s SAS links provide 4.8GB/s maximum bandwidth |
| | Logical Drives Supported | Zero Memory RAID has no cache memory |
| | Host Memory Addressing | 40-bit 512MB ECC protected flash back write cache |
| | RAID Support | 72-bit 1GB FBWC or 72-bit 2GB FBWC |
| | | Zero Memory, Up to 2 logical volumes (8SFF or 4LFF physical drives) |
| | | Up to 64 logical drives with cache |
| | | 64-bit, supporting greater than 4GB server memory space |

RAID 6, 60 (Advanced Data Guarding)
RAID 5, 50 (Distributed Data Guarding)

NOTE: A minimum of 512 MB cache is required to enable RAID 5, 50, 6, 60

NOTE: HP Smart Array Advanced Pack (SAAP 2.0) is no longer required to enable RAID 6 & 60 (Advanced Data Guarding). However, controller must be in firmware version 4.68 (or later).

RAID 10 (Striping & Mirroring)
RAID 0 (Striping), RAID 1 (Mirroring)

Technical Specifications

| | | |
|--|---|---|
| HP Ethernet 1Gb 4-port 331FLR Adapter | HP Flexible Network Technology Network Interface Compatibility | HP Flexible Network Technology consists of replaceable network solutions to meet customer requirements now and in the future. |
| | | 10Base-T/100Base-TX/1000Base-TX |
| | | IEEE 802.3 10Base-T |
| | | IEEE 802.3ab 1000Base-T |
| | | IEEE 802.3u 100Base-TX |
| | | IEEE 802.3ad 1000Base-TX |
| | | IEEE 802.1q 100Base-TX |
| | Data Transfer Method | PCI Express, four lanes (x4) |
| | Chipset | BCM5719 |
| | Network Transfer Rate | 10Base-T (Half-Duplex) 10 Mb/s |
| | | 10Base-T (Full-Duplex) 20 Mb/s |
| | | 100Base-TX (Half-Duplex) 100 Mb/s |
| | | 100Base-TX (Full-Duplex) 200 Mb/s |
| | | 1000Base-TX (Half and Full-Duplex) 2000Mb/s |
| | Connector | Four RJ-45 |
| | Cable Support | 10Base-T Categories 3, 4 or 5 UTP; up to 328 ft (100 m) |
| | | 100Base-TX Category 5 or higher UTP; up to 328 ft (100 m) |
| | | 1000BaseTX Category 5 or higher UTP; up to 328 ft (100 m) |

| | | |
|--|--|---|
| HP Ethernet 10Gb 2-port 530FLR-SFP+ Adapter | Network Interface Compatibility | SFP+ for Direct Attach Cable copper or fiber |
| | | IEEE 802.3 SFP+ (SX, SR & LR) |
| | | IEEE 802.3ae |
| | | IEEE 802.1ax |
| | | IEEE 802.1q |
| | | IEEE 802.3x |
| | | IEEE 802.1au |
| | | IEEE 802.3ap |
| | | IEEE 802.1Qaz |
| | | IEEE 802.1Qau |
| | | IEEE 802.1Qbb |
| | Data Transfer Method | PCI Express, eight lanes (x8) |
| | Chipset | BCM57810S |
| | Network Transfer Rate | 10Base-T (Half-Duplex) 10Gbps |
| | | 10Base-T (Full-Duplex) 1Gbps |
| | Connector | Two SFP+ |
| | Cable Support | 10Base-T Categories 3, 4 or 5 UTP; up to 328 ft (100 m) |

Technical Specifications

| | |
|------------|---|
| 100Base-TX | Category 5 or higher UTP; up to 328 ft (100 m) |
| 1000BaseTX | Category 5 or higher UTP; up to 328 ft (100 m) |

HP FlexFabric 10Gb 2-port 533FLR-T Adapter

| | |
|-----------------------------|--|
| Network Interface | 10GBASE-T connectivity supporting up to 100 meters with CAT 6A cabling |
| Compatibility | IEEE 802.3 IEEE 802.3x IEEE 802.2x IEEE 802.3ad IEEE 802.1Qaz IEEE 802.1Qau IEEE 802.1Qbb IEEE 802.1Qbg IEEE 802.1ax |
| Data Transfer Method | PCIe 2.0, eight lanes (x8) |
| Chipset | BCM57810S |
| Data Rate | Two ports, each at 20 Gbps full duplex; 40 Gbps aggregate full duplex theoretical bandwidth. |
| Connector | Two RJ-45 |
| Cable Support | Maximum distances for CAT6 cable are 30 meters (98 feet). Maximum distances for CAT6a are 100 meters (328 feet). |

Environment-friendly Products and Approach

End-of-life Management and Recycling

Hewlett-Packard offers end-of-life HP product return, trade-in, and recycling programs in many geographic areas. For trade-in information, please go to: <http://www.hp.com/go/green>. To recycle your product, please go to: <http://www.hp.com/go/green> or contact your nearest HP sales office. Products returned to HP will be recycled, recovered or disposed of in a responsible manner.

The EU WEEE directive (2002/95/EC) requires manufacturers to provide treatment information for each product type for use by treatment facilities. This information (product disassembly instructions) is posted on the Hewlett Packard web site at: <http://www.hp.com/go/green>. These instructions may be used by recyclers and other WEEE treatment facilities as well as HP OEM customers who integrate and re-sell HP equipment.

Technical Specifications

© Copyright 2013 Hewlett-Packard Development Company, L.P.

The information contained herein is subject to change without notice.

Microsoft and Windows NT are US registered trademarks of Microsoft Corporation.

Intel, the Intel logo, Xeon and Xeon Inside are trademarks of Intel Corporation in the U.S. and other countries.

The only warranties for HP products and services are set forth in the express warranty statements accompanying such products and services. Nothing herein should be construed as constituting an additional warranty. HP shall not be liable for technical or editorial errors or omissions contained herein.

For hard drives, 1GB = 1 billion bytes. Actual formatted capacity is less.